

# STRAC2 Quick Setup Guide



## Requirements

To begin, make sure you have the following equipment:

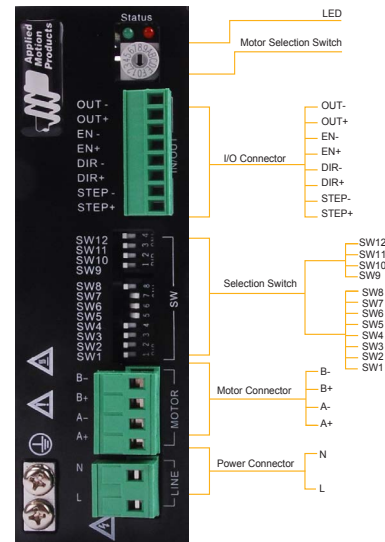

- A compatible stepper motor. Visit [applied-motion.com](http://applied-motion.com) to purchase one.
- A small flat blade screwdriver for tightening the connectors (included).
- An AC supply voltage, 90VAC-240VAC single-phase.
- A source of pulse & direction signals.



## Step 1 - Wiring AC Power Supply

**DO NOT** apply power until all connections to the drive have been made

a) Select Power input voltage **AC input voltage must be selected by switch. Check input voltage to avoid damage before powering on!**

Set 115 VAC 	Set 230VAC 
Supply voltage is 90 to 135 VAC:	Supply voltage is 135 to 240 VAC:

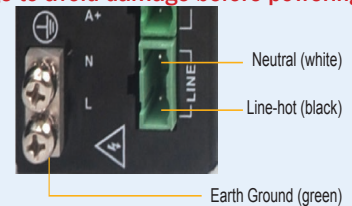

b) Wire the drive to the AC power source.

Use the connector supplied with the drive and one of the ground terminals on the drive to connect the AC supply according to the diagram to the right.

Use 16 AWG wire for Line (L) and Neutral (N). Use 14 AWG for Earth Ground (G)

## Step 2 - Wiring the Motor

Connect the drive to the motor.

If using a non Applied Motion Products' motor, consult the motor specs for wiring information.

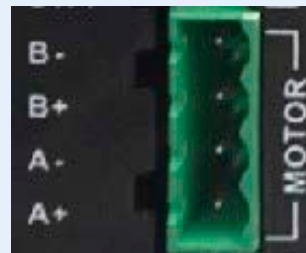
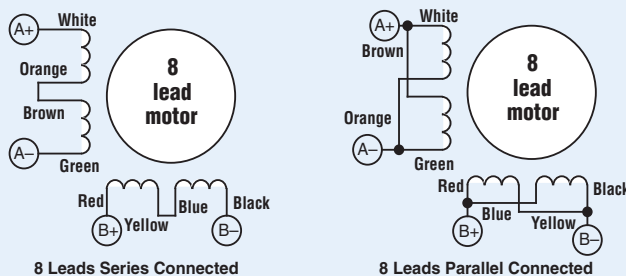

## Step 3 - Select the Motor

Each position of the 16-bit rotary switch selects a different motor, automatically setting the configuration parameters in the drive. The STRAC2 drive comes programmed with up to 16 typical motors as factory defaults. Drives can be customized with specially selected motors when required. Available options are in the hardware manual.

*If the motor selection is changed, the drive power supply will need to be cycled.*

For a custom motor, please select custom motor via the rotary switch, then use the DIP switches to configure motor current, anti-resonance and other settings.



## Step 4 - Config the Drive

Many operational parameters of the STRAC2 can be set or changed by DIP switches - either by a single switch or a combination of ON/OFF settings of 2 or more switches.

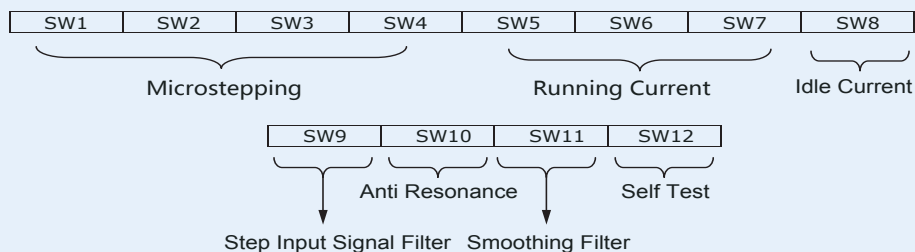

### 1. Microstepping - 4 switches for a total of 16 settings:

Microsteps(step/rev)	SW1	SW2	SW3	SW4
200	ON	ON	ON	ON
400	OFF	ON	ON	ON
800	ON	OFF	ON	ON
1600	OFF	OFF	ON	ON
3200	ON	ON	OFF	ON
6400	OFF	ON	OFF	ON
12800	ON	OFF	OFF	ON
25600	OFF	OFF	OFF	ON
1000	ON	ON	ON	OFF
2000	OFF	ON	ON	OFF
4000	ON	OFF	ON	OFF
5000	OFF	OFF	ON	OFF
8000	ON	ON	OFF	OFF
10000	OFF	ON	OFF	OFF
20000	ON	OFF	OFF	OFF
25000	OFF	OFF	OFF	OFF

### 2. Idle Current(SW8) - 1 switches for a total of 2 settings:

Idle	SW8
50%	ON
90%	OFF

### 3. Step Input Signal Filter (SW9) - ON for 150 kHz, OFF for 2 MHz

### 4. Running current - 3 switches for a total of 8 settings:

Current(Peak)	SW5	SW6	SW7
0.6A	ON	ON	ON
0.8A	OFF	ON	ON
1.0A	ON	OFF	ON
1.2A	OFF	OFF	ON
1.6A	ON	ON	OFF
1.8A	OFF	ON	OFF
2.0A	ON	OFF	OFF
2.5A	OFF	OFF	OFF

### 5. Anti-Resonance(SW10) - 1 switch for a total of 2 settings:

Option	SW10	Inertia
0	ON	Low
1	OFF	High

### 6. Step Smoothing Filter (SW11) - ON to enable, OFF to disable

## Step 5 - Self Test

The STRAC2 has a built in Self Test function. If switch 12 is moved to the ON position the drive will automatically rotate the motor back and forth, two turns in each direction. This feature can be used to confirm that the motor is correctly wired, selected and otherwise operational.

A full user manual for the STRAC2 is available for download from our website. This contains full details on setup, wiring and installation.

If you have any questions or comments, please call Applied Motion Products Customer Support: (800) 525-1609, or visit us online: [www.applied-motion.com](http://www.applied-motion.com).



404 Westridge Dr.  
Watsonville, CA 95076  
Tel: 800-525-1609  
[www.applied-motion.com](http://www.applied-motion.com)