

STM17

Hardware Manual

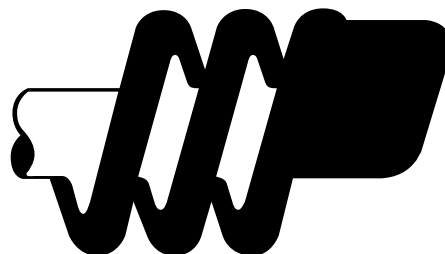
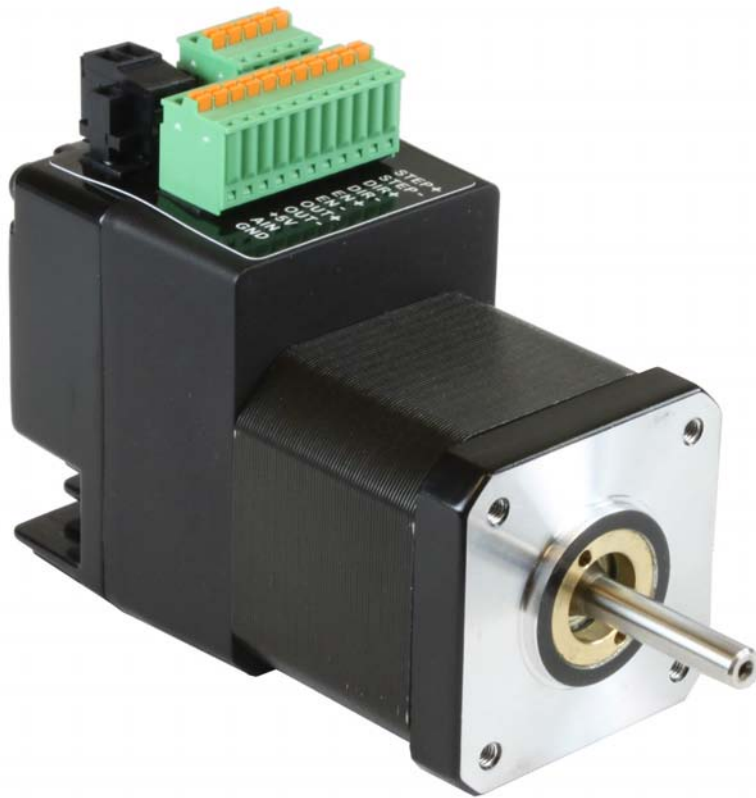

**Applied
Motion
Products**

Contents

Introduction.....	3
Block Diagram STM17S, STM17Q.....	4
Block Diagram STM17C.....	5
Safety Instructions.....	6
Getting Started.....	7
Installing Software.....	7
Mounting Hardware.....	7
Additional Reading.....	7
Choosing a Power Supply.....	8
Voltage Selection.....	8
Current Selection.....	10
Installation/Connections.....	12
Connecting the Power Supply.....	12
Connecting the STM17 Communications.....	13
Connecting to a PC using RS-232.....	13
Connecting to a host using RS-422/485.....	13
Four-Wire Configuration.....	14
Two-Wire Configuration.....	15
Assigning RS-485 Addresses.....	15
Connecting to an STM17 using USB.....	15
STM17 Inputs and Outputs.....	17
The Step (STEP) and Direction (DIR) Inputs.....	18
The Enable (EN) Digital Input.....	20
The Analog Input.....	21
The Digital Output.....	22
Reference Materials.....	23
Mechanical Outlines.....	23
Technical Specifications.....	24
Torque-Speed Curves.....	26
Drive/Motor Heating.....	30
Mating Connectors and Accessories.....	32
LED Error Codes.....	33
Contacting Applied Motion Products.....	33

Introduction

Thank you for selecting the Applied Motion Products STM17 Drive+Motor. We hope our dedication to performance, quality and economy will make your motion control project successful. If there's anything we can do to improve our products or help you use them better, please call us. We'd like to hear from you. Our phone number is (800) 525-1609. You can also email support@applied-motion.com.



Features

- Programmable, micro-stepping digital step motor and driver in an integrated package
- Operates from a 12 to 48 volt DC power supply
- Pulse/Direction, CW Pulse/CCW Pulse, or AB Quadrature
- Velocity (Oscillator) mode
- Streaming SCL commands
- Stored Q programs (-Q, -C models only)
- Encoder following (-Q models only)
- RS-232 or RS-422/485 communication (-S, -Q)
- CANopen DS301, DSP402 (-C only)
- Optional, internal encoder feedback
- Available torque up to 68 oz-in (0.48 N-m)
- Digital input filtering
- 3 optically isolated digital inputs, 5 to 24 volts
- Optically isolated digital output, 30V 100mA
- 12 bit analog input for speed and position control, 0 to 5 volts
- Step input signal smoothing (microstep emulation)
- Anti-resonance
- Electronic damping

Block Diagram STM17S, STM17Q

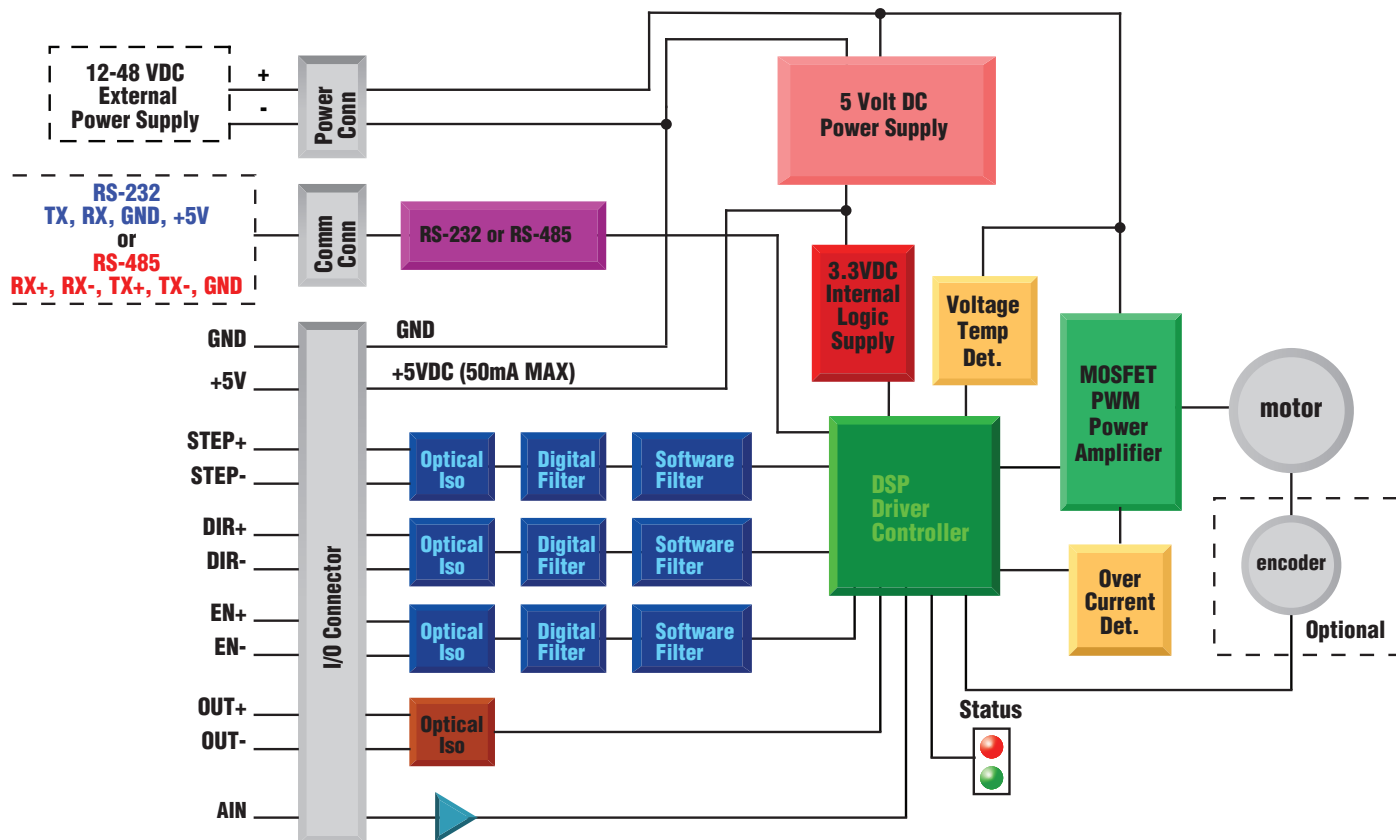

IO Functions (configure in software)			
STEP (5 to 24 Volts)	DIR (5 to 24 Volts)	EN (5 to 24 Volts)	OUT (30V, 80mA)
Step Input	Dir Input	Enable Input	Brake Output
Jog CW	Jog CCW	Reset Input	Alarm Output
Limit CW	Limit CCW	Change Speed	Motion Output
Start/Stop	General Purpose	General Purpose	Tach Output
General Purpose			General Purpose

Block Diagram STM17C

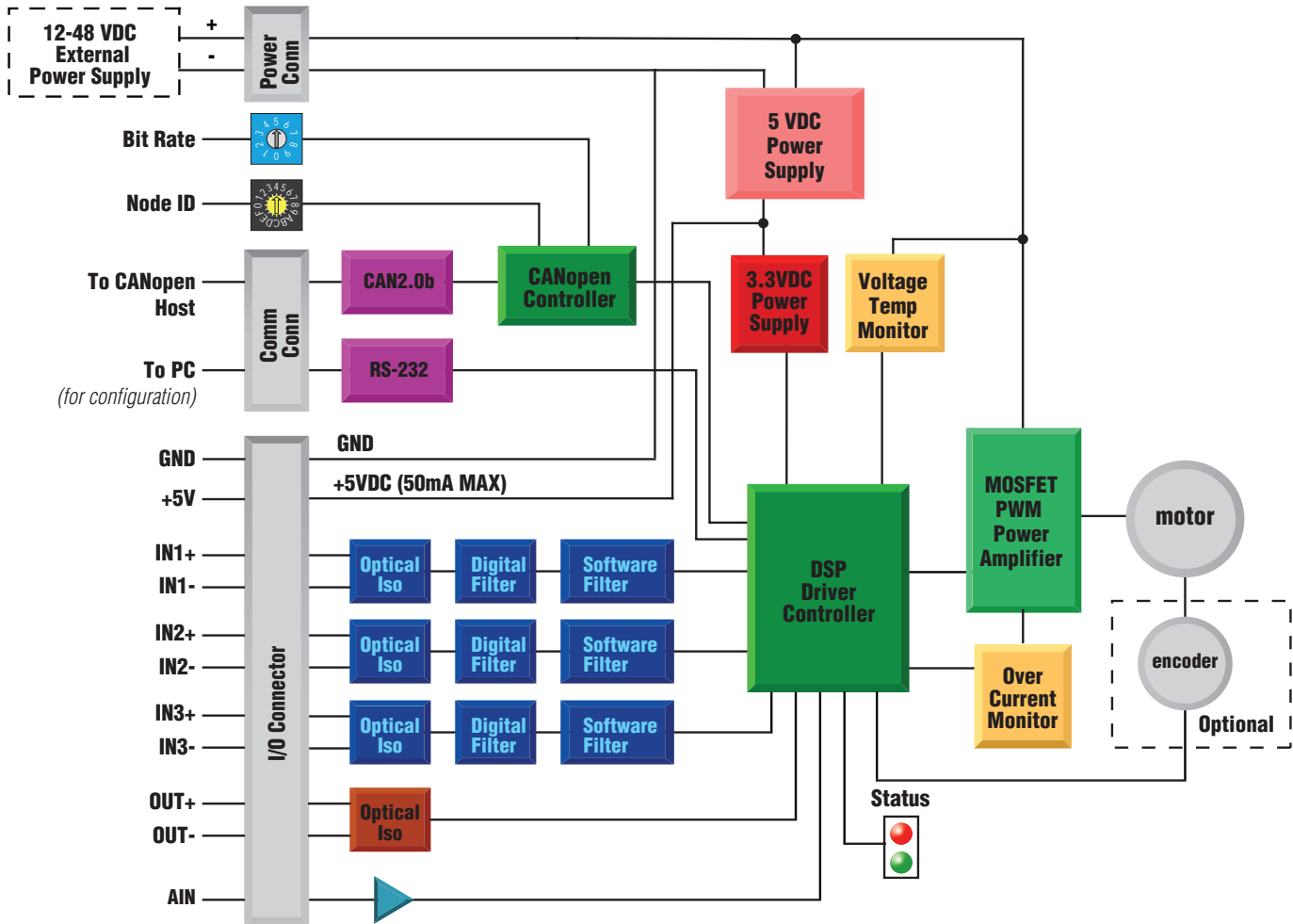

IO Functions (configure in software)

IN1 (5 to 24 Volts)	IN2 (5 to 24 Volts)	IN3 (5 to 24 Volts)	OUT (30V, 80mA)
Step Input	Dir Input	Enable Input	Brake Output
Jog CW	Jog CCW	Reset Input	Alarm Output
Limit CW	Limit CCW	Change Speed	Motion Output
Start/Stop	General Purpose	General Purpose	Tach Output
General Purpose			General Purpose

Safety Instructions

Only qualified personnel are permitted to transport, assemble, commission, and maintain this equipment. Properly qualified personnel are persons who are familiar with the transport, assembly, installation, commissioning and operation of motors, and who have the appropriate qualifications for their jobs. The qualified personnel must know and observe the following standards and regulations:

IEC 364 resp. CENELEC HD 384 or DIN VDE 0100

IEC report 664 or DIN VDE 0110

National regulations for safety and accident prevention or VBG 4

To minimize the risk of potential safety problems, you should follow all applicable local and national codes that regulate the installation and operation of your equipment. These codes vary from area to area and it is your responsibility to determine which codes should be followed, and to verify that the equipment, installation, and operation are in compliance with the latest revision of these codes.

Equipment damage or serious injury to personnel can result from the failure to follow all applicable codes and standards. We do not guarantee the products described in this publication are suitable for your particular application, nor do we assume any responsibility for your product design, installation, or operation.

- Read all available documentation before assembly and commissioning. Incorrect handling of products in this manual can result in injury and damage to persons and machinery. Strictly adhere to the technical information on the installation requirements.
- It is vital to ensure that all system components are connected to earth ground. Electrical safety is impossible without a low-resistance earth connection.
- The STM17 drives contain electrostatically sensitive components that can be damaged by incorrect handling. Discharge yourself before touching the product. Avoid contact with high insulating materials (artificial fabrics, plastic film, etc.). Place the product on a conductive surface.
- During operation keep all covers and cabinet doors shut. Otherwise, there are deadly hazards that could possibly cause severe damage to health or the product.
- In operation, depending on the degree of enclosure protection, the product can have bare components that are live or have hot surfaces. Control and power cables can carry a high voltage even when the motor is not rotating.
- Never pull out or plug in the product while the system is live. There is a danger of electric arcing and danger to persons and contacts.
- After powering down the product, wait at least ten minutes before touching live sections of the equipment or undoing connections (e.g., contacts, screwed connections). Capacitors can store dangerous voltages for long periods of time after power has been switched off. To be safe, measure the contact points with a meter before touching.

Be alert to the potential for personal injury. Follow the recommended precautions and safe operating practices included with the alert symbols. Safety notices in this manual provide important information. Read and be familiar with these instructions before attempting installation, operation, or maintenance. The purpose of this section is to alert users to possible safety hazards associated with this equipment and the precautions that need to be taken to reduce the risk of personal injury and damage to the equipment.

Failure to observe these precautions could result in serious bodily injury, damage to the equipment, or operational difficulty.

Getting Started

The following items are needed:

- a 12 - 48 volt DC power supply, see the section entitled "Choosing a Power Supply" for help in choosing one
- a small flat blade screwdriver for tightening the connectors (included)
- a PC running Microsoft Windows 98, 2000, NT, Me, XP, Vista, or Windows 7 and 8.
- a programming cable (included with RS-232 and CANopen models)

Installing Software

Before using the STM17 integrated motor and *ST Configurator* software in an application, the following steps are necessary:

- Install the ST Configurator software from www.applied-motion.com/products/software.
- Launch the software by clicking Start...Programs...Applied Motion Products.
- Connect the drive to the PC using the programming cable. When using RS-422/485, the drive must be set up in a 4-Wire configuration (see "Connecting to a host using RS-422/485".)
- Connect the drive to the power supply. See instructions.
- Apply power to the drive.
- The software will recognize the drive and display the model and firmware version. At this point, it is ready for use.

Mounting Hardware

As with any step motor, the STM17 must be mounted so as to provide maximum heat sinking and airflow. Keep enough space around the unit to allow for airflow.

Never use the drive where there is no airflow or where other devices cause the surrounding air to be more than 40°C (104°F).

Never put the drive where it can get wet.



Never use the drive where metal or other electrically conductive particles can infiltrate the drive.

Always provide airflow around the STM17.

Additional Reading

To learn more about *ST Configurator*, please refer to the built-in help. To learn more about the Q and SCL languages, please read the *Host Command Reference*, available at www.applied-motion.com.

Choosing a Power Supply

The main considerations when choosing a power supply are the voltage and current requirements for the application.

Voltage Selection

The STM17 is designed to give optimum performance between 12 and 48 Volts DC. Choosing the voltage depends on the performance needed and motor/drive heating that is acceptable and/or does not cause a drive over-temperature. Higher voltages will give higher speed performance but will cause the STM17 to produce higher temperatures. Using power supplies with voltage outputs that are near the drive maximum may significantly reduce the operational duty-cycle.

The extended range of operation can be as low as 10 VDC minimum to as high as 55 VDC maximum. When operating below 12 VDC, the power supply input may require larger capacitance to prevent under-voltage and internal-supply alarms. Current spikes may make supply readings erratic. The supply input cannot go below 12 VDC for reliable operation. Absolute minimum power supply input is 10 VDC. If the Input supply drops below 10 VDC the low voltage alarm will be triggered. This will not fault the drive, but the drive will likely power down.

Absolute maximum power supply input is 55 VDC at which time an over-voltage alarm and fault will occur. When using a power supply that is regulated and is near the drive maximum voltage of 55 VDC, a voltage clamp may be required to prevent over-voltage when regeneration occurs. The RC-050 Regeneration Clamp is recommended for the STM17 in this situation. When using an unregulated power supply, make sure the no-load voltage of the supply does not exceed the drive's maximum input voltage of 55 VDC.

The charts below show the heat output, in watts, of the drive at various speeds and voltages. See the section on "Duty Cycle Heating" in the Reference Materials for more information.

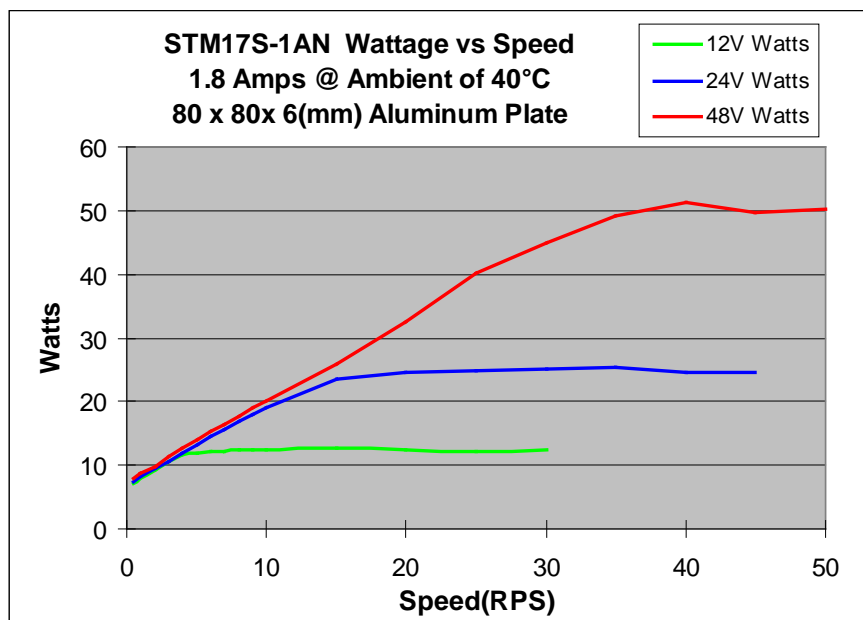

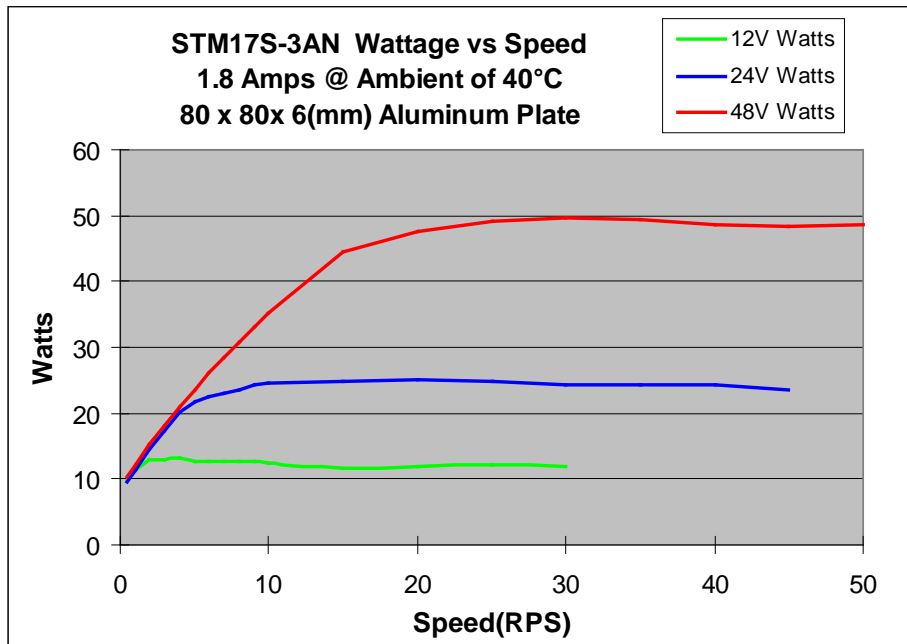
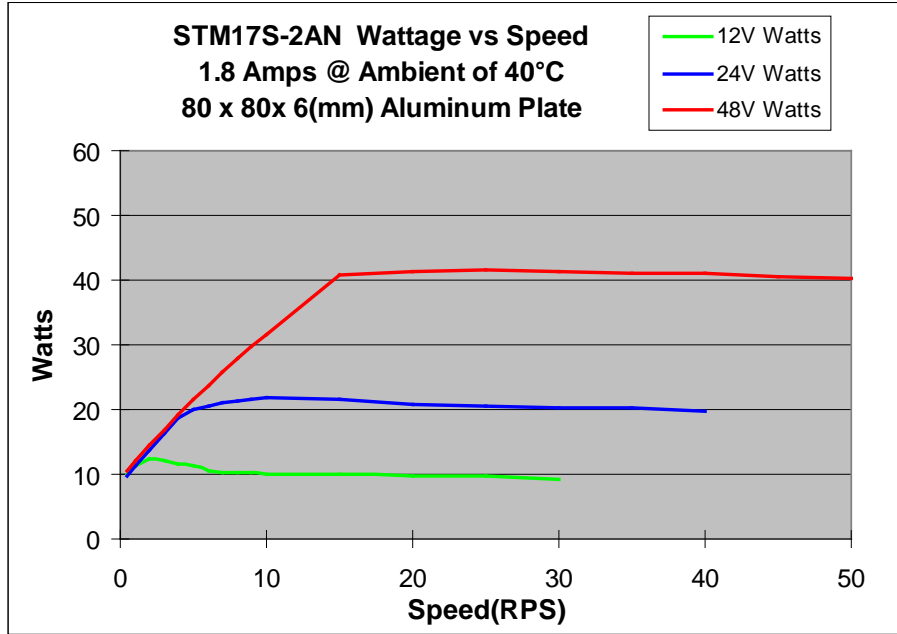

Current Selection

The maximum supply currents required by the STM17 are shown in the charts below at different power supply voltage inputs. The STM17 power supply current is lower than the winding currents because it uses switching amplifiers to convert a high voltage and low current into lower voltage and higher current. The more the power supply voltage exceeds the motor voltage, the less current will be required from the power supply.

It is important to note that the current draw is significantly different at higher speeds depending on the torque load to the motor. Estimating how much current is necessary may require a good analysis of the load the motor will encounter.

Note: all curves were measured at 20,000 steps/rev, 1.8A motor current, maximum torque load

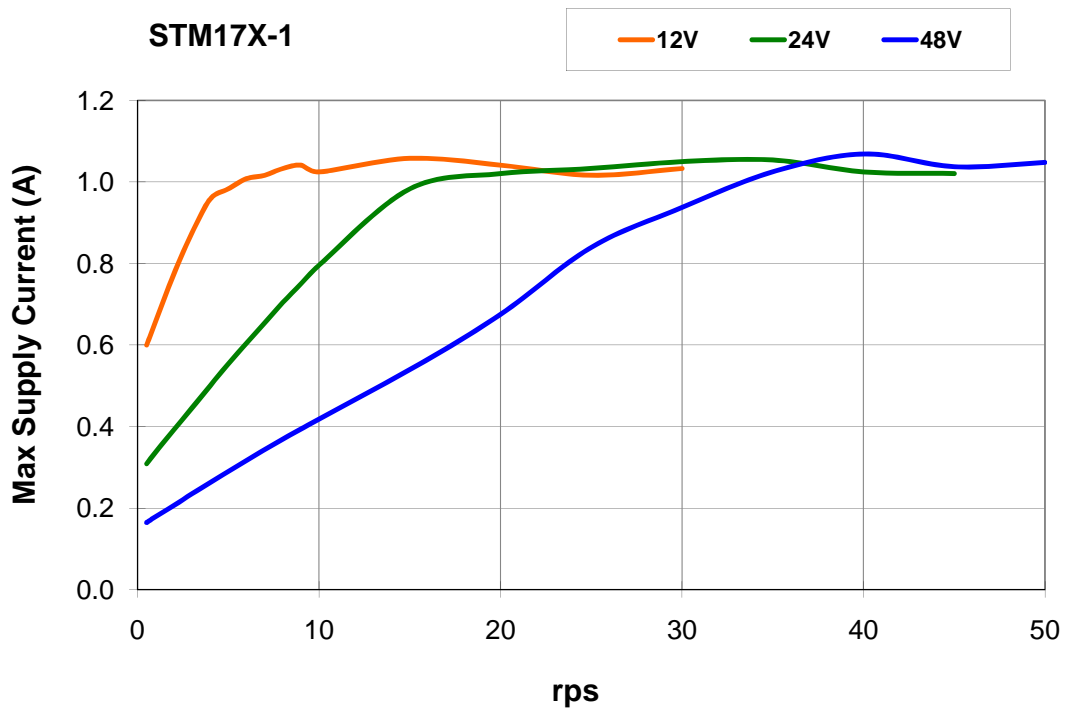

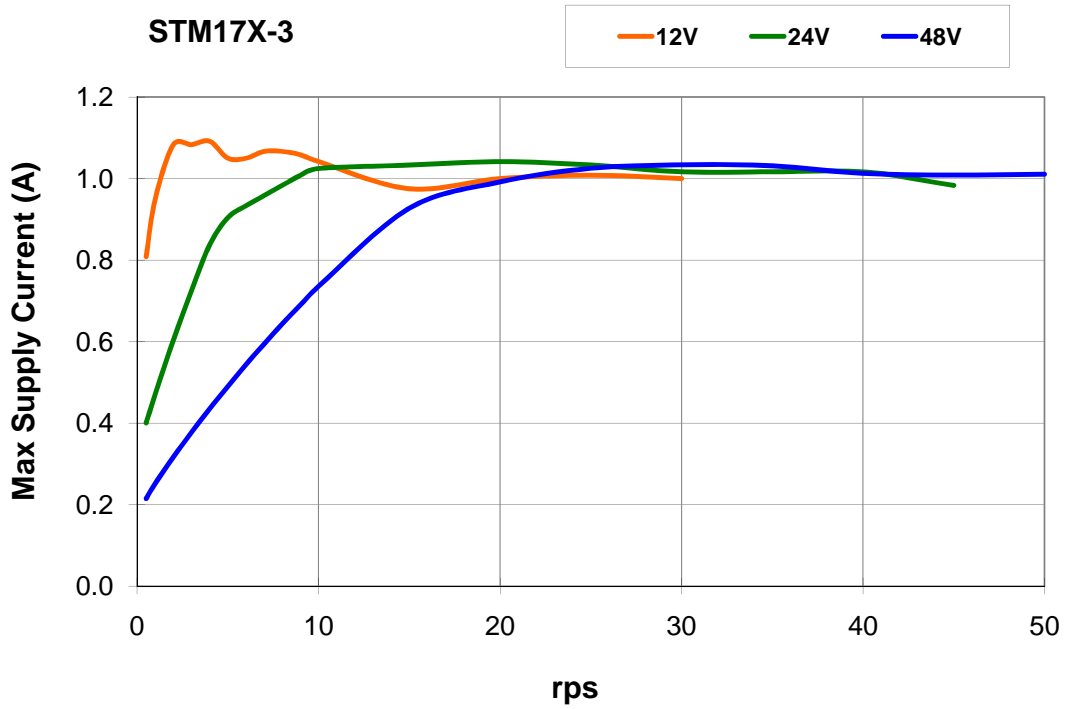
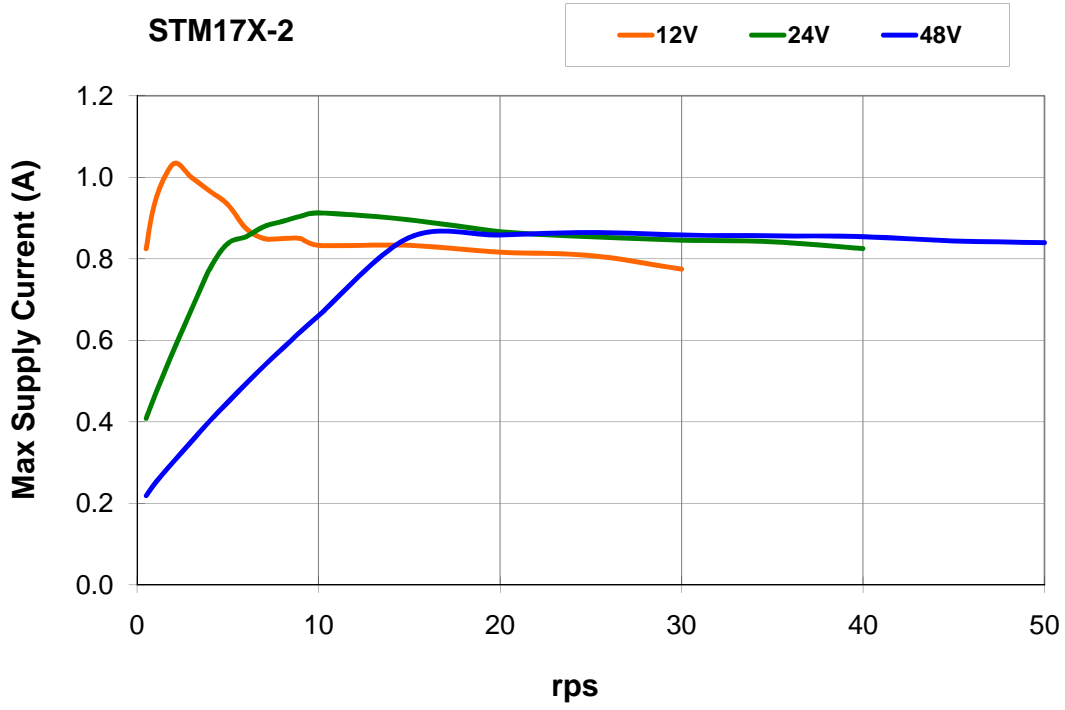

Installation/Connections

Connecting the Power Supply

Connect the power supply "+" terminal to the drive "+" terminal and the power supply "-" terminal to the drive "-" terminal using 16 to 20-gauge wire. The STM17 contains an internal fuse connected to the "+" terminal. This fuse is not user replaceable. If a user serviceable fuse is desired, install a 2 amp fast acting fuse in line with the "+" power supply lead.



Be careful not to reverse the wires. Reverse connection may open the internal fuse on your driver and void your warranty.



Power Supply Connections



RC-050 Regen Clamp

If a regulated power supply is being used, there may be a problem with regeneration. When a load decelerates rapidly from a high speed, some of the kinetic energy of the load is transferred back to the power supply, possibly tripping the over-voltage protection of a regulated power supply, causing it to shut down. This problem can be solved with the use of an RC-050 regeneration clamp. It is recommended that an RC-050 initially be installed in an application. If the "regen" LED on the RC-050 never flashes, the clamp is not necessary.

Connecting the STM17 Communications

The STM17 is available with two types of serial communications, RS-232 (STM17x-xAx) or RS-422/485 (STM17x-xRx). Each type requires a different hardware connection for interface to a PC or other host system. The RS-232 version comes with a cable that will provide the interface to an RS-232 port through a DB9 style connector. The RS-422/485 version requires the user to provide both the cabling and the RS-422/485 interface. Below are descriptions of how to interface both of these serial communication types to a PC.

Connecting to a PC using RS-232

Locate the STM17 within 8 feet (2.5 meters) of the PC. Plug the large end (DB9 connector) of the communication cable that came with the drive into the serial port of the PC. The small end will have a 5-pin spring clamp connector. Plug this end into the appropriate connector on the STM17. Secure the cable to the PC with the screws on the DB9 connector.

NOTE: If the PC does not have an RS-232 serial port, a USB Serial Converter will be needed. For more information, please read *Connecting to an STM17 Using USB*.

RS-232 Connector diagram

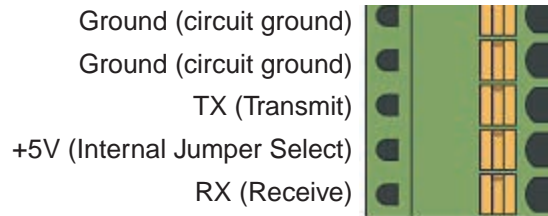

The RS-232 circuitry does not have any extra electrical "hardening" and care should be taken when connecting to the RS-232 port as hot plugging could result in circuit failure. If this is a concern the RS-422/485 version should be used.

Do not plug or unplug the RS-232 connection while power is applied to the drive. This is known as "hot plugging" and should be avoided.

Connecting to a host using RS-422/485

RS-422/485 communication allows connection of more than one drive to a single host PC, PLC, HMI or other computer. It also allows the communication cable to be long (more than 300 meters or 1000 feet). The use of Category 5 cable is recommended as it is widely used for computer networks, inexpensive, easily obtained and certified for quality and data integrity. Buy stranded Cat 5 for a good connection. Cat 5 has thinner insulation and two wires fit easily into the connector wire inlet for daisy chaining.

RS-422/485 versions of the STM17 can be used with either four-wire or two-wire configurations. Both types of configurations can be used for point-to-point (i.e. one drive and one host) or multi-drop networks (one host and up to 32 drives).

NOTE: To use the STM17 RS-422/485 version with the ST Configurator software, the STM17 must be connected to the PC in the four-wire "point to point" configuration (see below) and configured one axis at a time.

Four-Wire Configuration

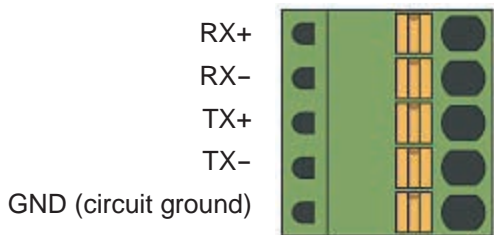

RS-422/485 Connector diagram

Four-wire Systems utilize separate transmit and receive wires. One pair of wires must connect the host's transmit signals to each drive's RX+ and RX- terminals. The other pair connects the drive's TX+ and TX- terminals to the host's receive signals. A logic ground terminal is provided on each drive and can be used to keep all drives at the same ground potential. This terminal connects internally to the DC power supply return (V-), so if all the drives on the RS-422/485 network are powered from the same supply it is not necessary to connect the logic grounds. One drive's GND terminal should still be connected to the host computer ground.

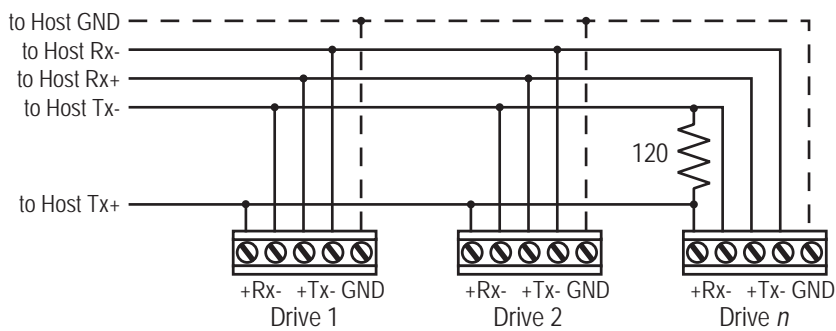

RS-422/485 4-wire system

NOTE: a 120 ohm terminating resistor is required at the end of a four wire network.

NOTE: If the PC does not have an RS-422/485 serial port, a converter will be required.

Two-Wire Configuration

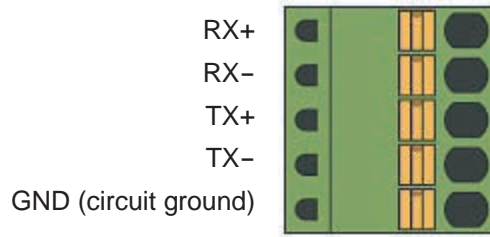

RS-422/485 Connector diagram

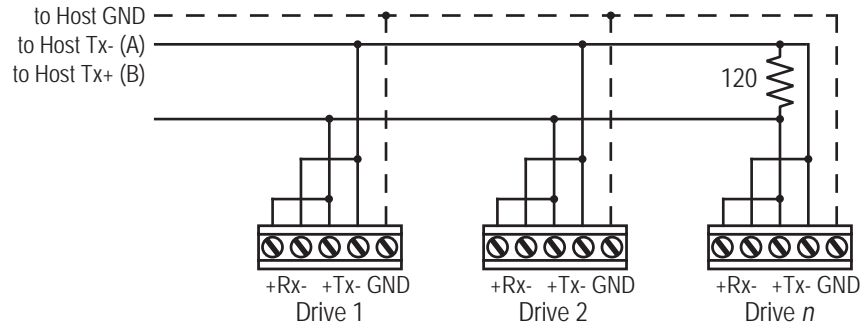

Typical RS-422/485 Two-Wire System

Transmit and receive on the same pair of wires can lead to trouble. The host must not only disable its transmitter before it can receive data, it must do so quickly, before a drive begins to answer a query. The STM17 includes a “transmit delay” parameter that can be adjusted to compensate for a host that is slow to disable its transmitter. This adjustment can be made over the network using the TD command, or it can be set using the *ST Configurator* software. It is not necessary to set the transmit delay in a four-wire system.

NOTE: a 120 ohm terminating resistor is required at the end of the network

RS-232 to RS-485 2-wire Converter

Model 485-25E from [Integrity Instruments](http://www.integrityinstruments.com) (800-450-2001) works well for converting your PC’s RS-232 port to RS-485. It comes with everything you need. Connect the adaptor’s “B” pin to the STM17 drive’s TX+ and RX+ terminals. Connect “A” to the drive’s TX- and RX- terminals.

Assigning RS-485 Addresses

Before wiring the entire system, you’ll need to connect each drive individually to the host computer so that a unique address can be assigned to each drive. Use the programming cable and the *ST Configurator*™ software that came with your drive for this purpose.

Connect the drive to your PC and then launch the *ST Configurator*™ software. Finally, apply power to your drive. If you have already configured your drive, then you should click the Upload button so that the *ST Configurator*™ settings match those of your drive. Click on the Motion button, then select the “SCL” operating mode. If you have a Q drive, you may want to select “Q Programming”. Either way, you’ll see the RS-485 Address panel appear. Just click on the address character of your choice. You can use the numerals 0..9 or the special characters ! " # \$ % & ' () * + , - . / : ; < = > ? @ . Just make

sure that each drive on your network has a unique address. If you are using a 2-wire network, you may need to set the Transmit Delay, too. 10 milliseconds works on the adapters we've tried. Once you've made your choices, click Download to save the settings to your drive.

Connecting to an STM17 using USB

The USB-COMi-M from www.byterunner.com is an excellent choice for USB to serial conversion. It can be used for all RS-232, RS-422 and RS-485 applications. The USB-COM-CBL can be used for USB to RS-232 connection only. Both adapters are available from byterunner.com. These adapters use the FTDI chip set and are compatible with Windows XP and later, including 64 bit versions.

Note: Prolific-based USB serial adapters do not work with Vista 64 or Windows 7 64 bit operating systems.

For RS-232 conversion using the USB-COMi-M, use the DB9 connector and set the switches according to the diagram below. The DB-9 connector is not used for RS-485.

RS-232

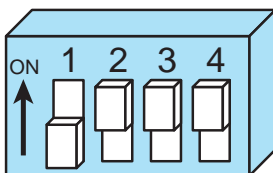

USB-COMi-M Switch Settings

For RS-485 two wire systems, set the switches and make the connections to the STM17 according the diagrams below.

USB-COMi-M 6 pin screw terminal connector	STM17 5 pin connector
1	RX-, TX-
2	RX+, TX+
6	GND

2 Wire RS-485

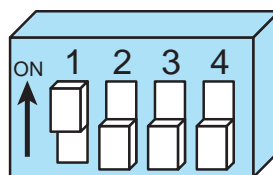

For RS-485 four wire systems, set the switches and make the connections to the STM17 according the diagrams below.

USB-COMi-M 6 pin screw terminal connector	STM17 5 pin connector
1	RX-
2	RX+
3	TX+
4	TX-
6	GND

4 Wire RS-485

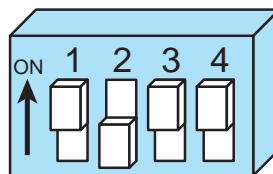

STM17 Inputs and Outputs

All STM drive+motors include three digital inputs, one analog input, and one digital output.

- STEP & DIR: 5 to 24 volt digital input signals for commanding position. When not being used for the Step & Direction function, these inputs can be used for CW & CCW Limit, CW & CCW Jogging and Run/Stop & Direction Velocity modes. These inputs can also be connected to sensors, switches and other devices for use with SCL and Q commands such as Wait Input, Seek Home, Feed to Sensor, If Input and others. Quadrature signals from encoders can also be used.
- EN: 5 to 24 volt software programmable input can be used for motor enable or alarm reset. This input can also be connected to a sensor, switch and other devices for use with Wait Input, Seek Home, Feed to Sensor, If Input and other commands.
- AIN: 0 - 5V analog input for velocity or position commands, with gain, filtering, offset and dead-band settings.
- OUT: digital output that can be set to automatically control a motor brake, to signal a fault condition, to indicate when the motor is moving or to provide an output frequency proportional to motor speed (tach signal). The output can also be turned on and off by SCL & Q instructions like Set Output (SO).

Connector Pin Diagram

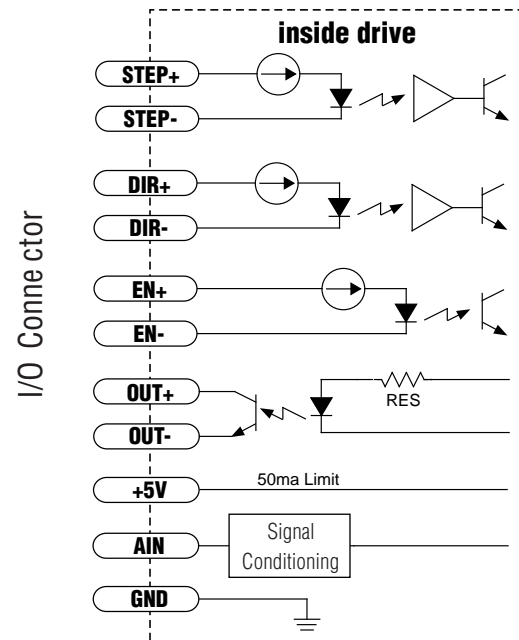

IO Functions (configure in software)			
STEP (5 to 24 Volts)	DIR (5 to 24 Volts)	EN (5 to 24 Volts)	OUT (30V, 80mA)
Step Input	Dir Input	Enable Input	Brake Output
Jog CW	Jog CCW	Reset Input	Alarm Output
Limit CW	Limit CCW	Change Speed	Motion Output
Start/Stop	General Purpose	General Purpose	Tach Output
General Purpose			General Purpose

The Step (STEP) and Direction (DIR) Inputs

The STM17 drive+motors include two high-speed inputs called STEP and DIR. They accept 5 to 24 volt single-ended or differential signals, up to 2 MHz. Typically these inputs connect to an external controller that provides step & direction command signals. You can also connect a master encoder to the high-speed inputs for “encoder following” applications. Or you can use these inputs with Wait Input, If Input, Feed to Sensor, Seek Home and other SCL or Q commands.

Note: If current is flowing into or out of an input, the logic state of that input is low or closed. If no current is flowing, or the input is not connected, the logic state is high or open.

Example connection diagrams:

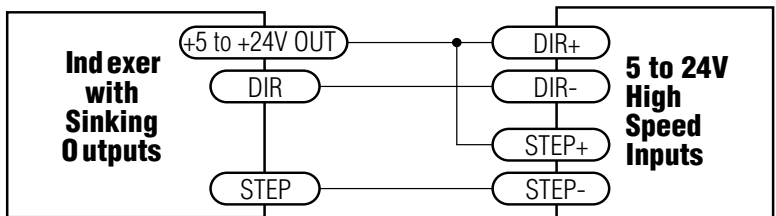

Connecting to indexer with Sinking Outputs

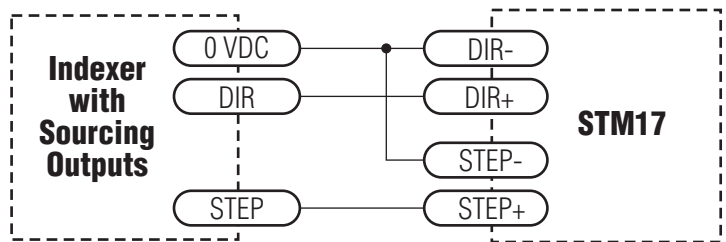

Connecting to indexer with Sourcing Outputs

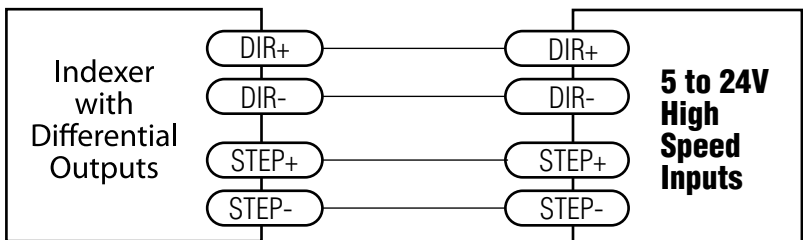

Connecting to Indexer with Differential Outputs
(Many High Speed Indexers have Differential Outputs)

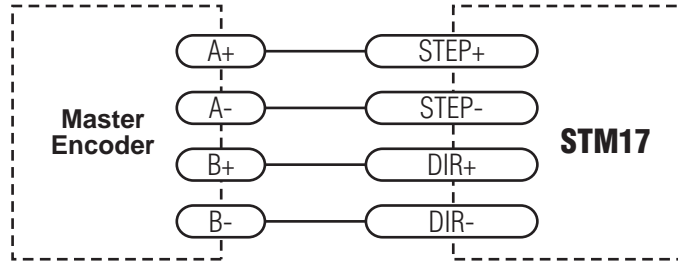

Wiring for Encoder Following

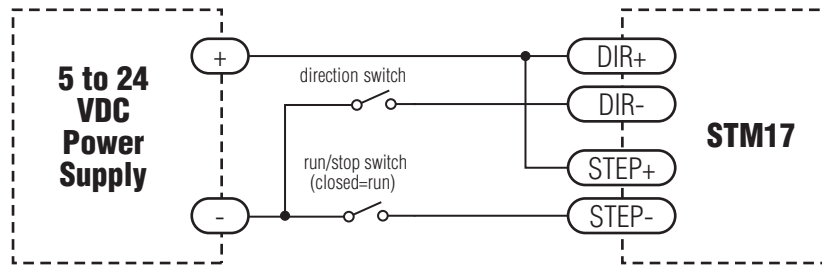

Using Mechanical Switches

The Enable (EN) Digital Input

As mentioned in the previous section, the high-speed STEP and DIR inputs are designed for high speed operation. The Enable digital input is designed for low speed digital input operation between 5 and 24 volts DC.

Note: If current is flowing into or out of an input, the logic state of that input is low or closed. If no current is flowing, or the input is not connected, the logic state is high or open.

Example connection diagrams:

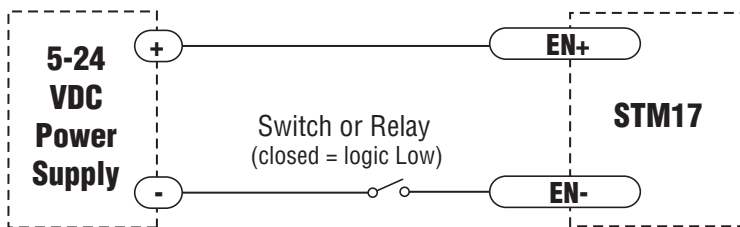

Connecting the Input to a Switch or Relay

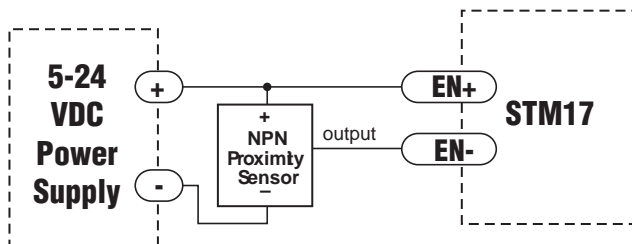

Connecting an NPN Type Proximity Sensor to an input
(When prox sensor activates, input goes low).

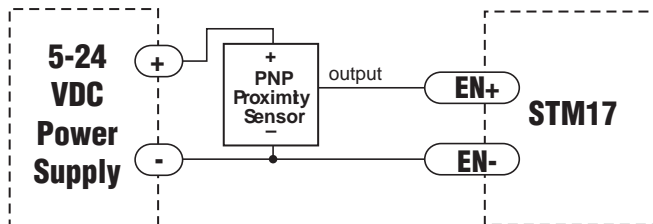

Connecting a PNP Type Proximity Sensor to an input
(When prox sensor activates, input goes low).

The Analog (AIN) Input

The STM17 drives feature an analog input. The input can accept a signal range of 0 to 5 VDC. The drive can be configured to operate at a speed or position that is proportional to the analog signal. Use the *ST Configurator* software to set the signal range, offset, dead-band and filter frequency. The STM17 drives also provide a +5VDC 100ma output that can be used to power external devices such as potentiometers. It is not the most accurate supply for reference; for more precise readings use an external supply that can provide the desired accuracy.

Example connection diagram:

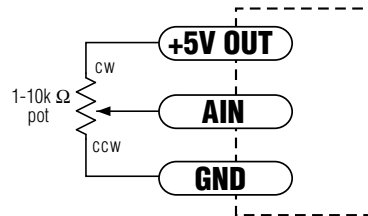
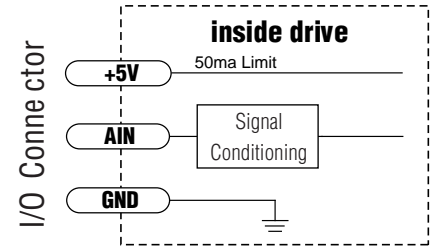

Connecting a Potentiometer to the Analog Input

The Digital Output

The STM17 drives feature one optically isolated digital output. This output can be set to automatically control a motor brake, to signal a fault condition, to indicate when the motor is moving or to provide an output frequency proportional to motor speed (tach signal). The output can also be turned on and off by program instructions like Set Output. The output can be used to drive LEDs, relays and the inputs of other electronic devices like PLCs and counters. The "OUT+" (collector) and "OUT-" (emitter) terminals of the transistor are available at the connector. This allows you to configure the output for current sourcing or sinking.

Note: If current is flowing into or out of an output, the logic state of that output is low or closed. If no current is flowing, or the output is not connected, the logic state is high or open.

**Do not connect the output to more than 30VDC.
The current through the output terminal must not exceed 40mA.**

Example connection diagrams:

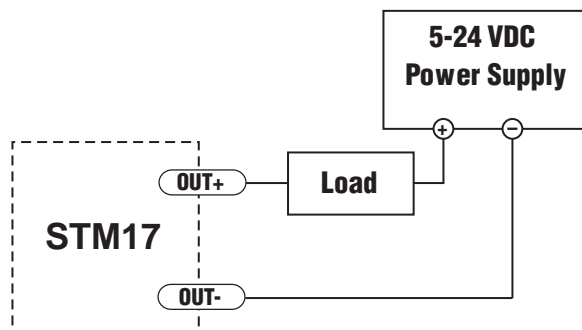

Connecting a Sinking Output

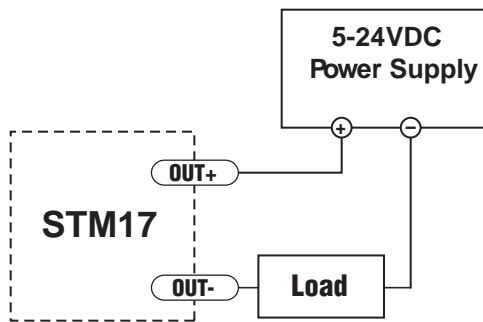

Connecting a Sourcing Output

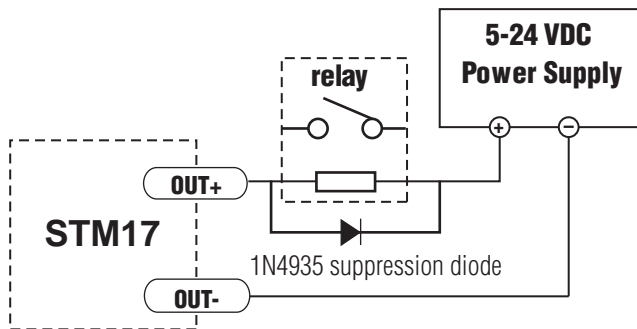

Driving a Relay

Reference Materials

Mechanical Outlines

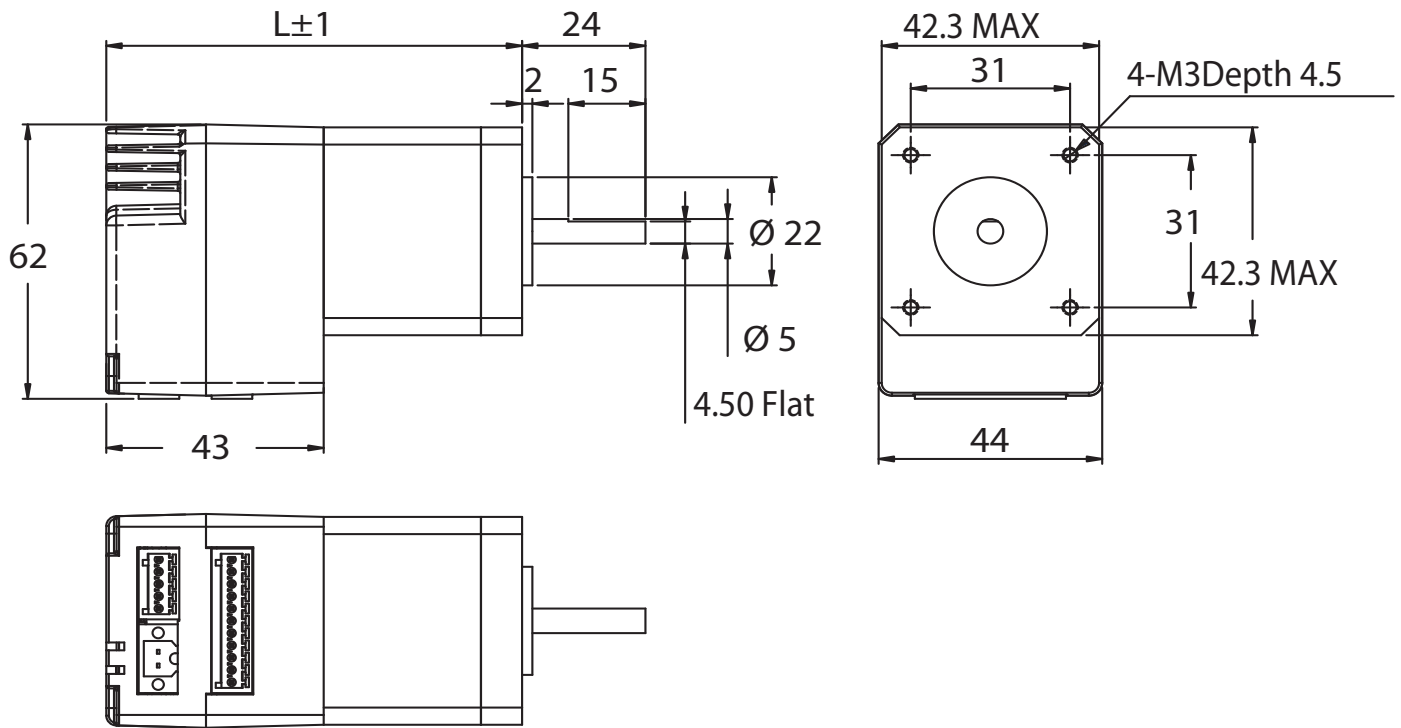

Model	Length (L) in mm
STM17x-1	67
STM17x-2	72.5
STM17x-3	81

Technical Specifications

POWER AMPLIFIER	
Amplifier Type	Dual H-Bridge, 4 Quadrant
Current Control	4 state PWM at 16 KHz
Output Torque	STM17x-1x Series – to 31 oz-in with suitable power supply STM17x-2x Series – to 54 oz-in with suitable power supply STM17x-3x Series – to 68 oz-in with suitable power supply
Power Supply	External 12-48 volt power supply required
Input Voltage Range	10-55 volts min/max (nominal 12-48 volts), voltages outside this range may cause driver faults and/or may damage the device
Protection	Over-voltage, under-voltage, over-temp, internal motor shorts (phase-to-phase, phase-to-ground)
Idle Current Reduction	Reduction range of 0–90% of running current after a delay selectable in milliseconds

CONTROLLER	
Current Control	Advanced digital current control provides excellent high speed torque
Microstep Resolution	Software selectable from 200 to 51200 steps/rev in increments of 2 steps/rev
Speed Range	Speeds up to 80 rps
Distance Range	Over 10,000,000 revolutions (at 200 steps/rev)
Anti Resonance (Electronic Damping)	Raises the system-damping ratio to eliminate midrange instability and allow stable operation throughout the speed range of the motor
Auto Setup	Measures motor parameters and configures motor current control and anti-resonance gain settings
Self Test	Checks internal and external power supply voltages, diagnoses open motor phases
Microstep Emulation	Performs high resolution stepping by synthesizing coarse steps into fine microsteps
Dynamic Smoothing	Software configurable filtering for use in removing spectral components from the command sequence, reduces jerk, limiting excitation of system resonance
Dynamic Current Control	Software configurable for running current, accel current, idle current, to make motion smoother and the motor run cooler

Multiple Modes Of Control	Pulse Input - Step & Direction, CW/CCW, A/B Quadrature (incremental encoder) Velocity - Analog Velocity, Switch Control Velocity, Serial Commanded Velocity Serial Command Language (SCL) Stored Program Execution (Q models only)
Noise Filtering	Programmable hardware digital noise filter, software noise filter
Encoder Feedback	Optional 4000 counts/rev encoder feedback
Non-Volatile Storage	Configurations are saved in FLASH memory on-board the DSP

INPUTS AND OUTPUTS	
Step Input	STEP +/- Inputs: optically isolated, 5-24 volts, minimum pulse width 250 ns., maximum pulse frequency 3 MHz. Max current draw 12mA. Functions: Step, CW Step, A Quadrature, CW Limit, CW Jog, general purpose input; adjustable bandwidth digital noise rejection filter
Direction Input	DIR +/- Inputs: optically isolated, 5-24 volts, minimum pulse width 250 ns., maximum pulse frequency 3 MHz. Max current draw 12mA. Functions: DIR, CCW Step, B Quadrature, CCW Limit, CCW Jog, general purpose input; adjustable bandwidth digital noise rejection filter
Enable Input	EN +/- Inputs: optically isolated, 5-24 volts, minimum pulse width 100 us., maximum pulse frequency 10 KHz. Max current draw 12mA. Functions: Enable, alarm reset, speed control, general purpose input; adjustable bandwidth digital noise rejection filter
Output	OUT +/- Open Collector, 30 volts, 100 mA max, maximum pulse frequency 10 KHz Functions: Fault, brake, motion, tach, and general purpose programmable
Analog Input	AIN Input: 0-5 volts (AIN referenced to GND). Input impedance: 30k ohms min. Functions: analog control modes and general purpose analog usage; programmable for signal range, offset, dead band and filtering
Analog Input Resolution	12 bits
Communication Interface	RS-232 or RS-422/485
Supply Output	+4.8-5 volts @ 100mA maximum

PHYSICAL & ENVIRONMENTAL	
Mass	STM17x-1xx: 292 g (10.3 oz) STM17x-2xx: 360 g (12.7 oz) STM17x-3xx: 441 g (15.6 oz)
Rotor Inertia	STM17x-1xx: 38 g-cm ² (0.21 oz-in ²) STM17x-2xx: 57 g-cm ² (0.31 oz-in ²) STM17x-3xx: 82 g-cm ² (0.45 oz-in ²)
Ambient Temperature	0-40 °C (32-104 °F) when mounted to a suitable heatsink
Humidity	90% non-condensing

Torque-Speed Curves

Note: all torque curves were measured at 20,000 steps/rev, 1.8A motor current

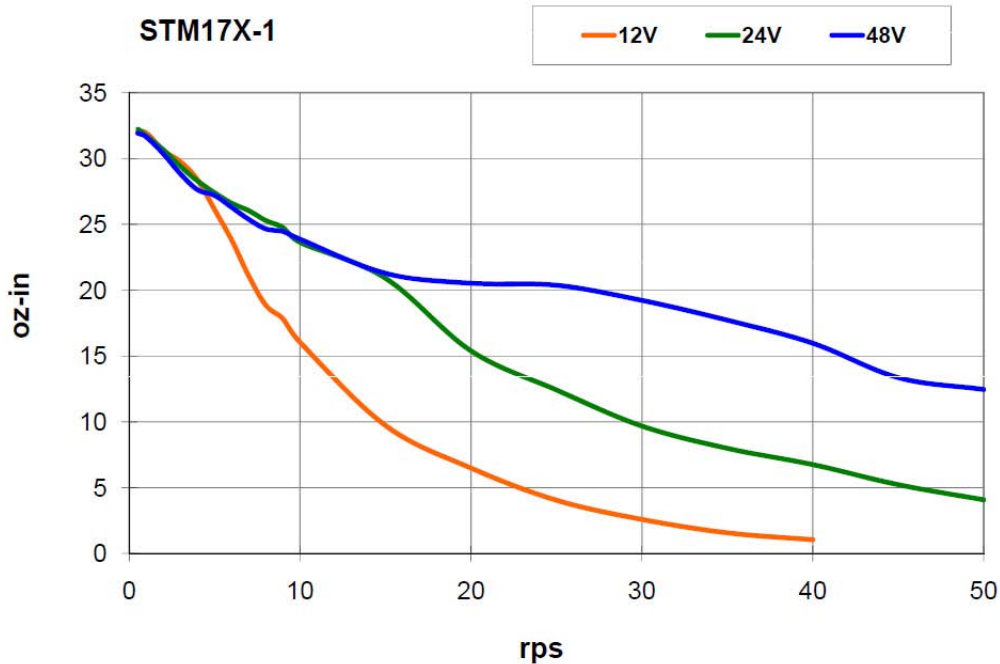

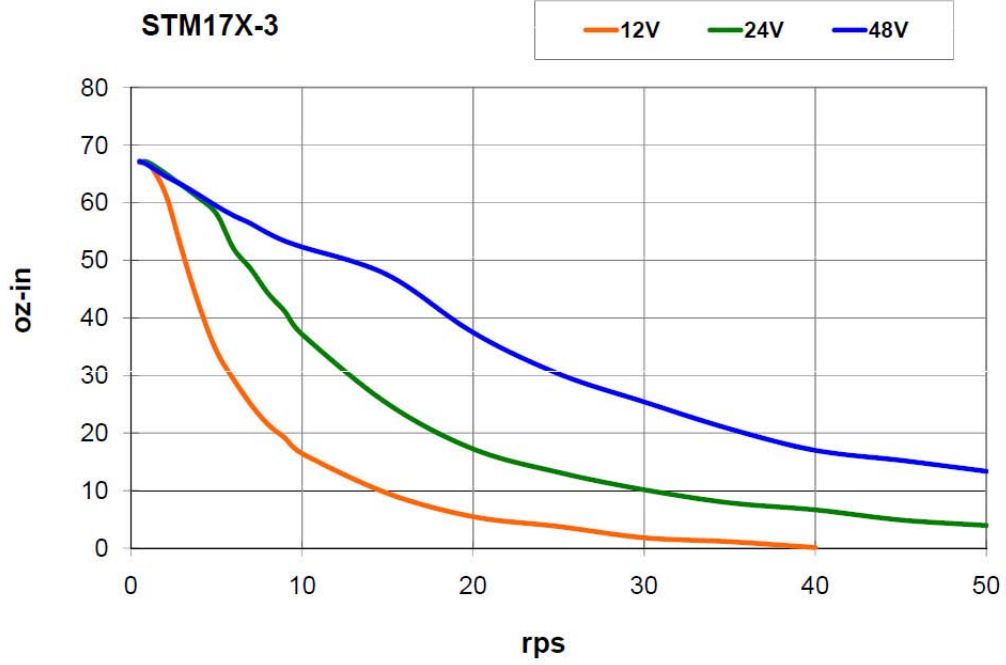
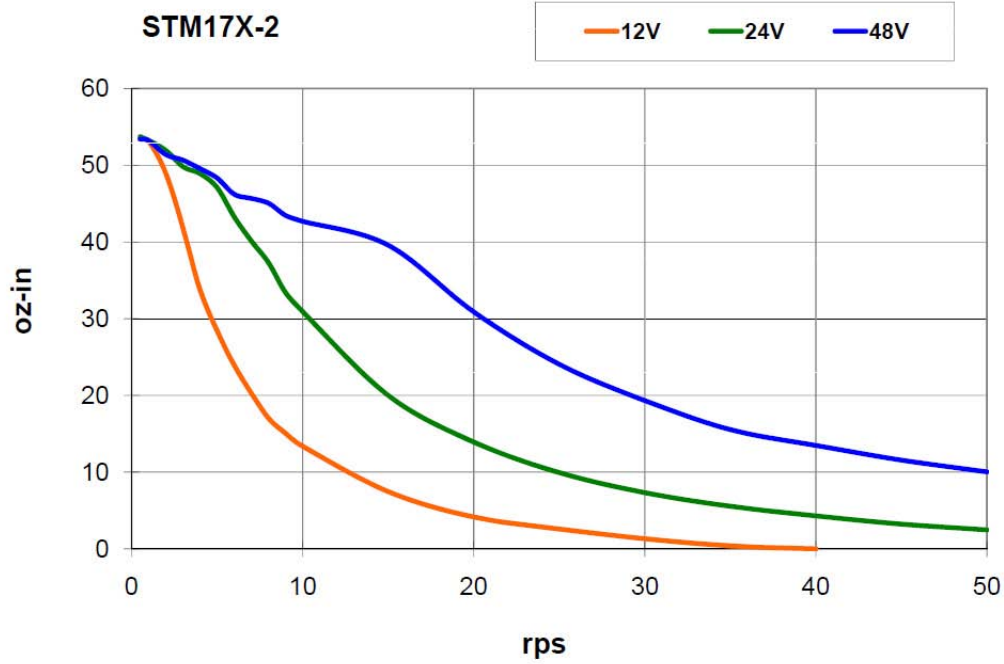

Drive/Motor Heating

Step motors convert electrical power from the driver into mechanical power to move a load. Because step motors are not perfectly efficient, some of the electrical power turns into heat on its way through the motor. This heating is not so much dependent on the load being driven but rather the motor speed and power supply voltage. There are certain combinations of speed and voltage at which a motor cannot be continuously operated without damage.

We have characterized the STM17 Drive+Motors in our lab and provided curves showing the maximum duty cycle versus speed for each size at commonly used power supply voltages. Please refer to these curves when planning your application.

Please also keep in mind that a step motor typically reaches maximum temperature after 30 to 45 minutes of operation. If you run the motor for one minute then let it sit idle for one minute, that is a 50% duty cycle. Five minutes on and five minutes off is also 50% duty. However, one hour on and one hour off has the effect of 100% duty because during the first hour the motor will reach full (and possibly excessive) temperature.

The actual temperature of the motor depends on how much heat is conducted, convected or radiated out of it. Our measurements were made in a 40°C (104°F) environment with the motor mounted to an aluminum plate sized to provide a surface area consistent with the motor power dissipation. Your results may vary.

Please use the curves below, which show the motor body temperature, to determine the maximum duty cycle of the Drive+Motor under various conditions.

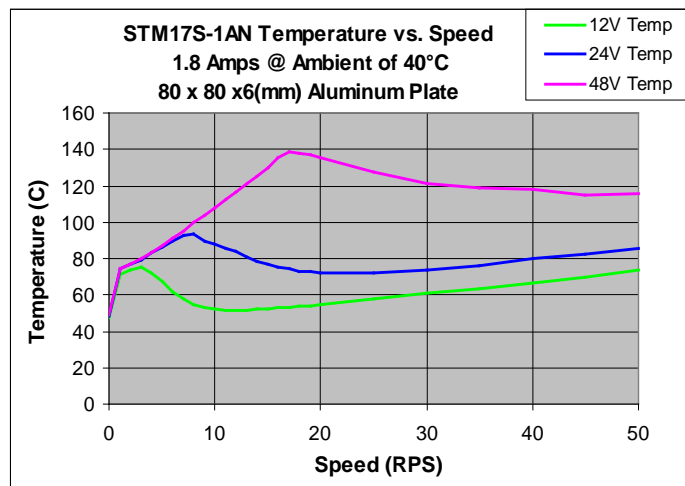
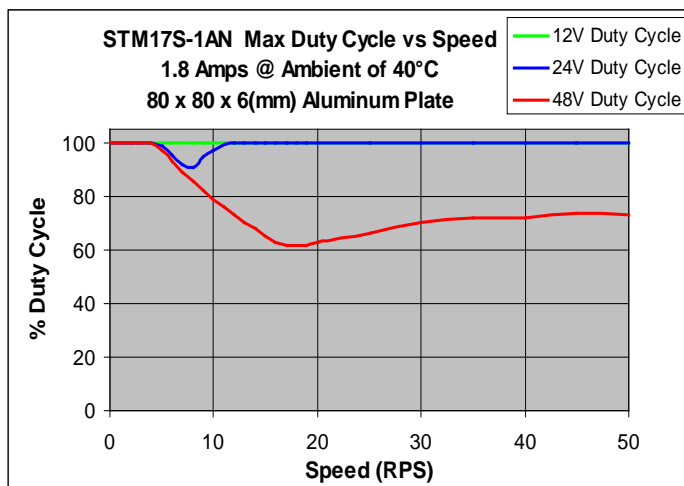

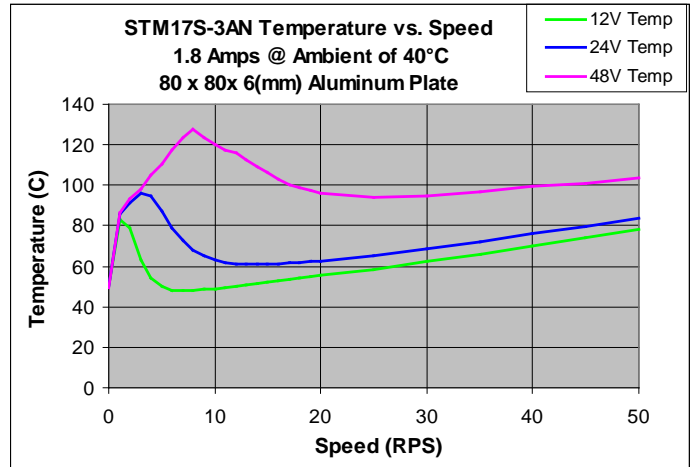
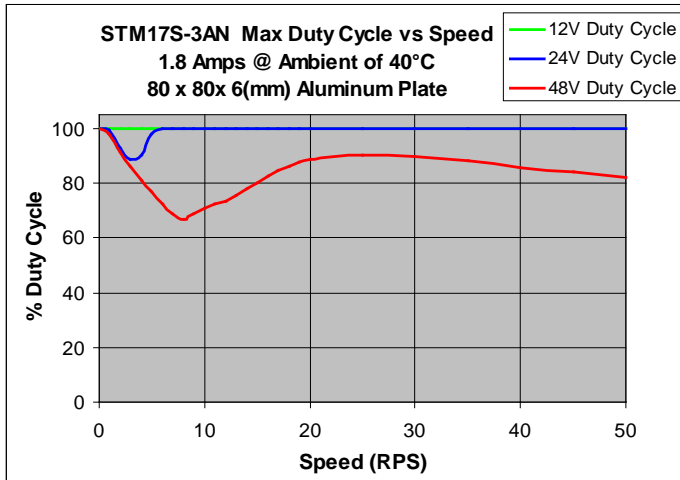
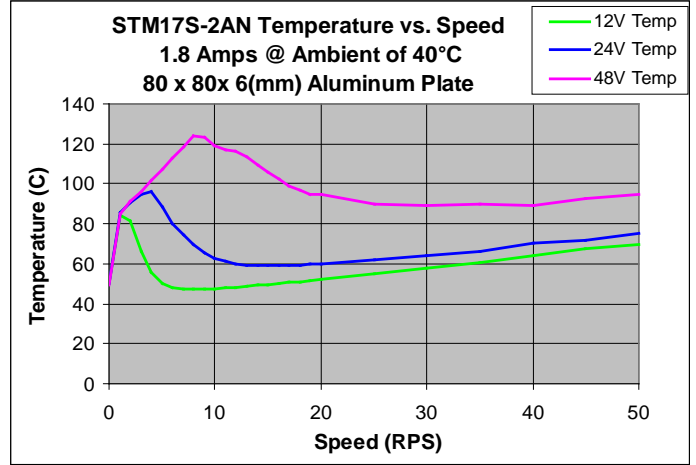
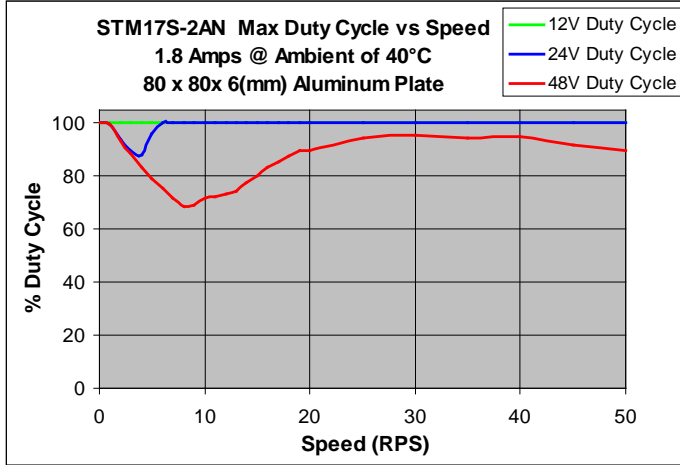

Mating Connectors and Accessories

Mating Connector (Type)	PART NO
DC Power (2-position, screw terminal)	Weidmuller 1615780000
I/O (11-position, spring cage)	Phoenix 1881419
Comm (5-position, spring cage)	Phoenix 1881354

Accessories

USB-Serial Adapter with one RS-232 port and one RS-485 port for programming all units: P/N 8500-003

DC Power Supplies:

24V, 50W switching power supply, P/N PS50A24

24 V, 150W switching power supply, P/N PS150A24















48 V, 320W switching power supply, P/N PS320A48

Regeneration Clamp for Applications with High Inertial Loads

RC-050

LED Status & Error Codes

The STM drive+motor includes red and green LEDs to indicate status. When the motor is enabled, the green LED flashes slowly. When the green LED is solid, the motor is disabled. Errors are indicated by combinations of red and green “flashes” as follows:

Code	Condition
 solid green	no alarm, motor disabled
 flashing green(slow)	no alarm, motor enabled
 flashing green(fast)	Q Program running
 1 red, 1 green	motor stall (optional encoder only)*
 1 red, 2 green	move attempted while drive disabled
 2 red, 1 green	ccw limit
 2 red, 2 green	cw limit
 3 red, 1 green	drive overheating*
 3 red, 2 green	internal voltage out of range*
 3 red, 3 green	blank Q segment
 4 red, 1 green	power supply overvoltage*
 4 red, 2 green	power supply undervoltage
 5 red, 1 green	over current / short circuit*
 6 red, 1 green	open motor winding*
 7 red, 1 green	serial communication error

Contacting Applied Motion Products

Corporate Headquarters
 404 Westridge Drive
 Watsonville, CA 95076
 (831) 761-6555
 web www.applied-motion.com
support@applied-motion.com