

Hardware Manual

STM17R

Drive+Motor



920-0054B
3/26/2012



Contents

Introduction	3
Features	3
Block Diagram	4
Getting Started.....	5
Mounting the STM17R.....	6
Connecting the Power Supply	7
Choosing a Power Supply.....	8
Voltage	8
Current.....	8
Connecting Input Signals.....	11
Connector Pin Diagram.....	11
Mating Cable Diagram.....	11
Internal Circuit Diagram	11
Connection Examples: STEP & DIR	12
Connection Examples: EN.....	12
Connecting the Digital Output.....	14
Using the Optional Encoder	15
Configuring the STM17R	16
Step 1: Setting the Current	16
Step 2: Setting Idle Current	16
Step 3: Load Inertia.....	17
Step 4: Step Size.....	17
Step 5: Step Pulse Type.....	19
Step 6: Step Pulse Noise Filter.....	20
Self Test	20
Reference Materials.....	21
Torque-Speed Curves.....	21
Heating.....	22
Mechanical Outlines	24
Technical Specifications	26
Mating Connectors and Accessories.....	27
Alarm Codes	28
Connector Diagram	28
Mating Cable	28

Introduction

Thank you for selecting an Applied Motion Products motor control. We hope our dedication to performance, quality and economy will make your motion control project successful.

If there's anything we can do to improve our products or help you use them better, please call or fax. We'd like to hear from you. Our phone number is (800) 525-1609, or you can reach us by fax at (831) 761-6544. You can also email support@applied-motion.com.

Features

- Low cost, digital step motor+driver in a compact package
- Operates from Step & Direction signals or Step CW & Step CCW (switch selectable)
- Enable input
- Fault output
- Optically isolated I/O
- Digital filters prevent position error from electrical noise on command signals
- Electronic damping and anti-resonance
- Automatic idle current reduction to reduce heat when motor is not moving.
Switch selectable: 50%, 70%, 90% or 100% of rated current
- Switch selectable step resolution: 200 (full step), 400 (half step), 800, 1600, 3200, 6400, 12800, 25600, 1000, 2000, 4000, 5000, 8000, 10000, 20000 and 25000 steps/rev
- Switch selectable microstep emulation provides smoother, more reliable motion in full and half step modes
- Automatic self test (switch selectable)
- Operates from a 12 to 48 volt DC power supply
- Up to 68 oz-in torque

Block Diagram

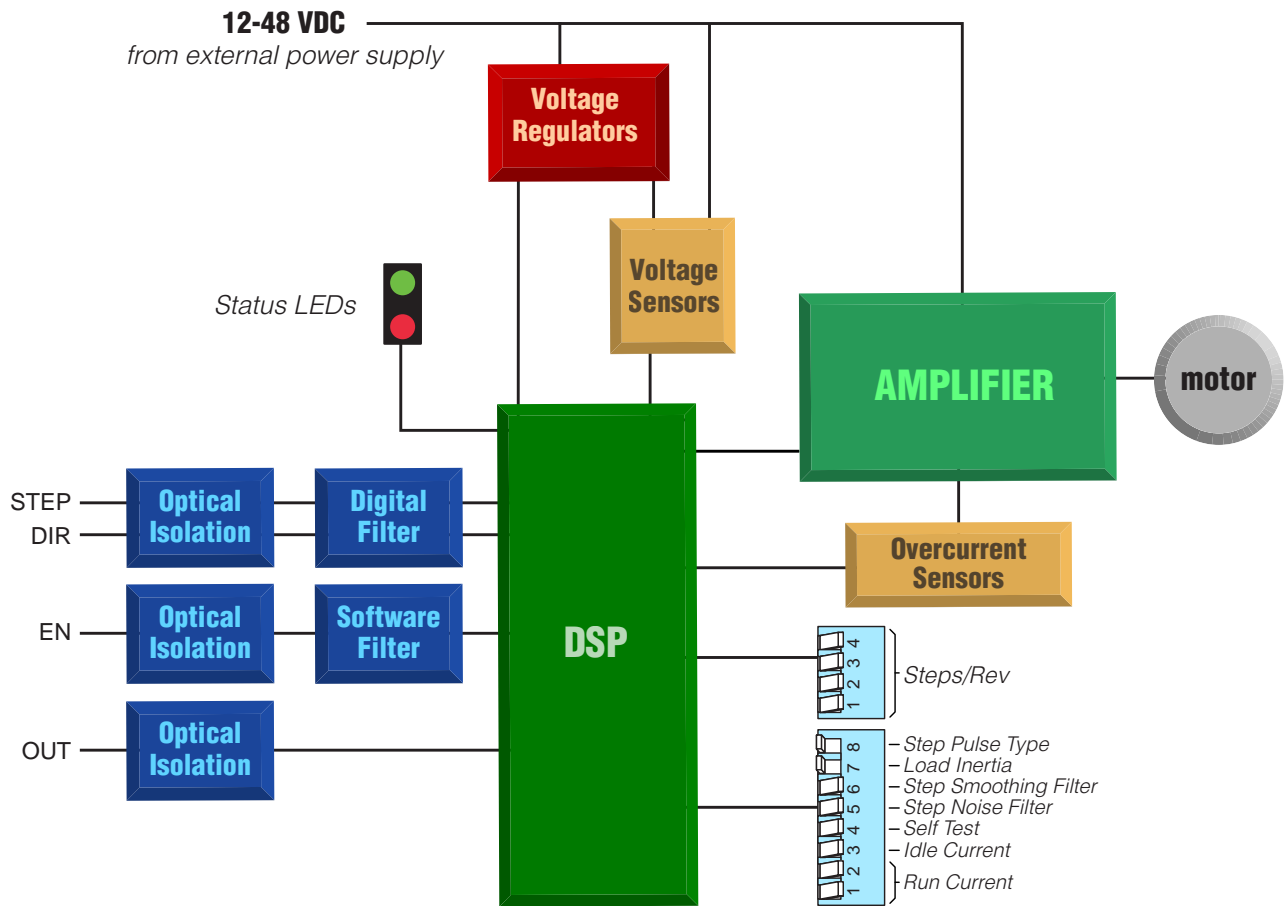

Getting Started

To get started with your STM17R, you'll need the following:

- a 12 to 48 volt DC power supply. Please read the section *Choosing a Power Supply* for help in choosing the right power supply.
- a tool for inserting wires into the connector.
- a source of step signals, such as a PLC or motion controller.

The connectors and other points of interest are illustrated below. These are detailed later in the manual.

Status LED

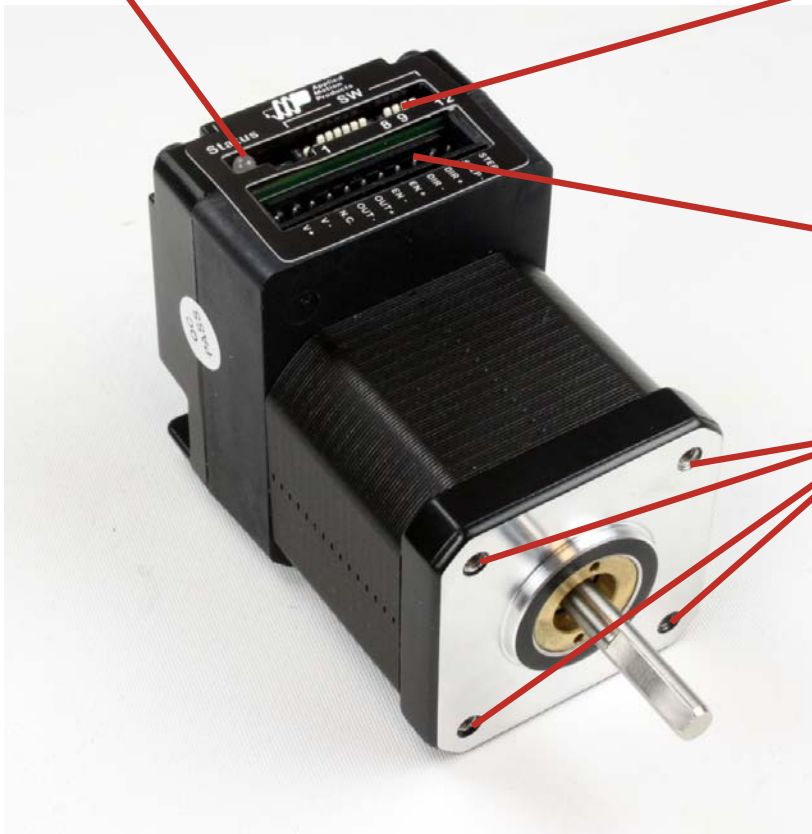

DIP switches
(current,
idle current,
steps/rev,
load inertia)

Power & Signal
Connector

Mounting holes

Mounting the STM17R

You can mount your motor+drive using four M3 screws (mounting hole depth is 4.5 mm). If possible, the motor+drive should be securely fastened to a smooth, flat metal surface that will help conduct heat away from the motor. If this is not possible, then forced airflow from a fan may be required to prevent the STM17R from overheating. See page 22 for more details about heating.

- ***Never use your motor+drive in a space where there is no air flow or where other devices cause the surrounding air to be more than 40°C.***
- ***Never put the STM17R where it can get wet or where metal or other electrically conductive particles can get on the circuitry.***
- ***Always provide air flow around the drive. When mounting multiple STM17R's near each other, maintain at least one half inch of space between them.***

Connecting the Power Supply

If you need information about choosing a power supply, please read the section *Choosing a Power Supply*.

- Connect the power supply "+" terminal to connector terminal 11.
- Connect power supply "-" to connector terminal 10.
- Use 22 gauge stranded wire.

The STM17R contains an internal fuse that connects to the power supply + terminal. This fuse is not user replaceable. If you want to install a user serviceable fuse in your system install a fast acting 2 amp fuse in line with the + power supply lead.

(1)STEP+	ORANGE
(2)STEP-	BROWN
(3)DIR+	YELLOW
(4)DIR-	GREEN
(5)EN+	BLUE
(6)EN-	PURPLE
(7)OUT+	GRAY
(8)OUT-	WHITE
(9)N.C.	WHITE/GREEN
(10)V-	BLACK
(11)V+	RED



Be careful not to reverse the wires. Reverse connection will destroy your drive, void your warranty and generally wreck your day.

If you plan to use a regulated power supply you may encounter a problem with regeneration. If you rapidly decelerate a load from a high speed, much of the kinetic energy of that load is transferred back to the power supply. This can trip the overvoltage protection of a switching power supply, causing it to shut down. We offer the RC-050 "regeneration clamp" to solve this problem. If in doubt, buy an RC-050 for your first installation. If the "regen" LED on the RC-050 never flashes, you don't need the clamp.



regen LED

RC-050 Regen Clamp

Choosing a Power Supply

When choosing a power supply, there are many things to consider. If you are manufacturing equipment that will be sold to others, you probably want a supply with all the safety agency approvals. If size and weight are an issue get a switching supply.

And you must decide what size of power supply (in terms of voltage and current) is needed for your application.

Applied Motion offers three power supplies that are excellent matches for the STM17R: PS50A24 (24V, 2A), PS150A24 (24V, 6.3A) and PS320A48 (48V, 6.7A).

Voltage

Your motor can provide more torque at higher speeds if a higher power supply voltage is used. Please consult the speed-torque curves later in this manual for guidance.

If you choose an unregulated power supply, make sure the no load voltage of the supply does not exceed 50 volts DC

Current

The charts on the following pages list the maximum current required for each motor at several common power supply voltages. Please consider this information when choosing a power supply.

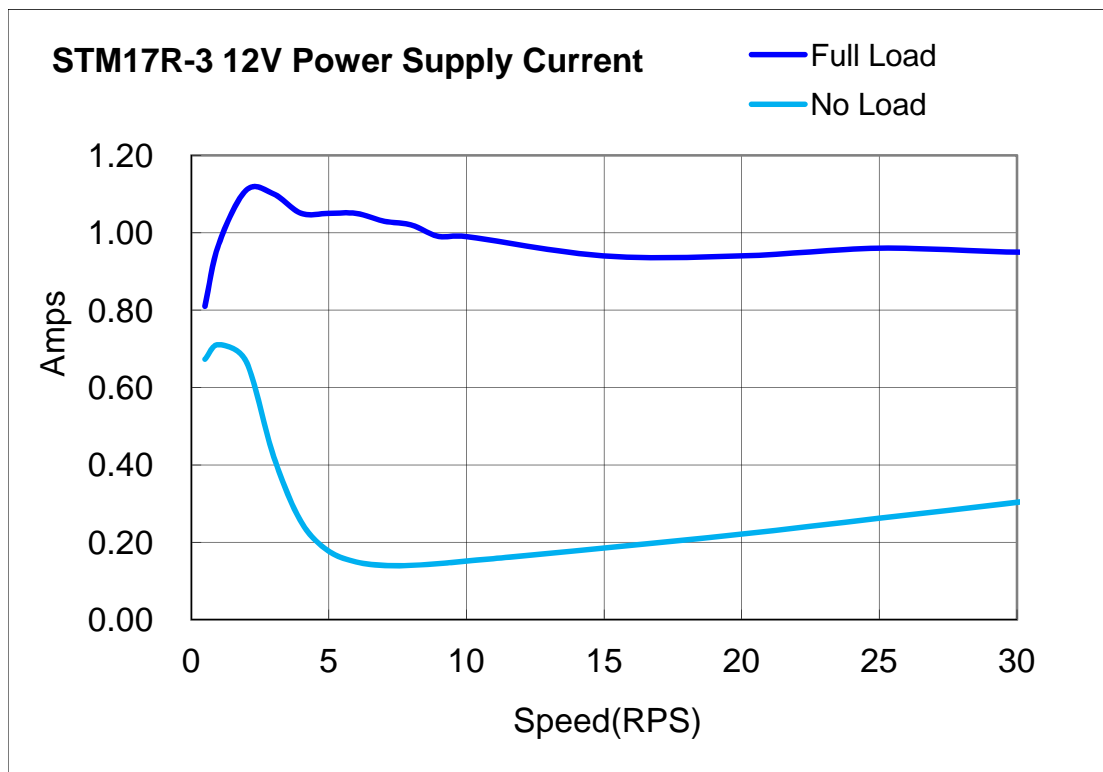

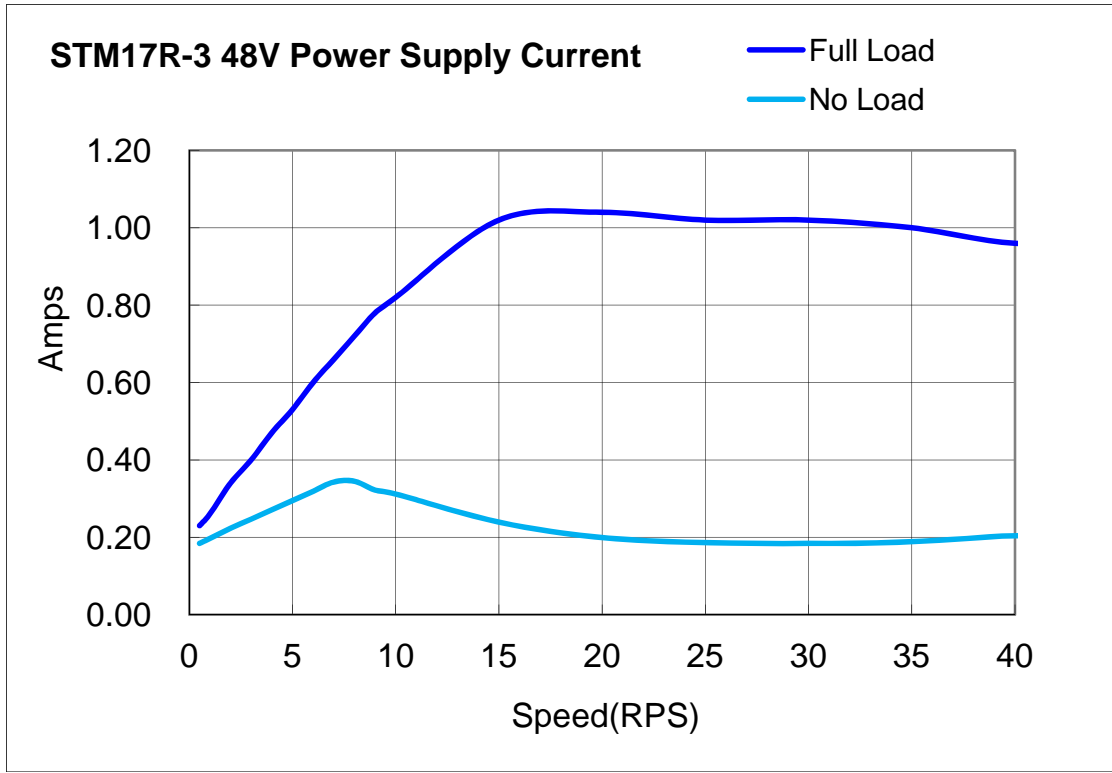
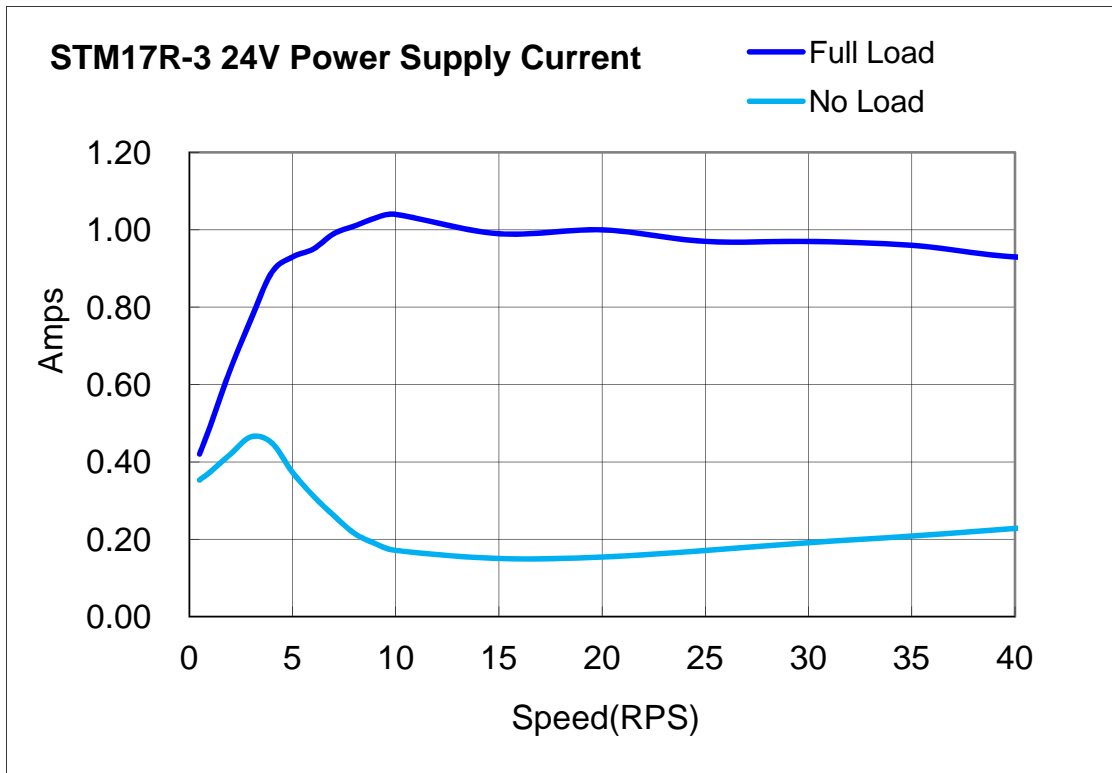

Regeneration

If you plan to use a regulated power supply you may encounter a problem with regeneration. If you rapidly decelerate a load from a high speed, much of the kinetic energy of that load is transferred back to the power supply. This can trip the overvoltage protection of a switching power supply, causing it to shut down. Unregulated power supplies are better because they generally do not have overvoltage protection and have large capacitors for storing energy coming back from the drive. They are also less expensive. See previous section on *Connecting the Power Supply* for details on the RC-050 regeneration clamp.

Connecting Input Signals

The STM17R has three inputs:

- STEP: a high speed digital input for step pulse commands, 5-24 volt logic
- DIR: a high speed digital input for the direction signal, 5-24 volt logic
- EN: a 5-24V input for commanding the removal of power from the motor

Note: STEP and DIR inputs can be converted to STEP CW and STEP CCW by moving switch #8 to the ON position. See Page 19.

Connector Pin Diagram

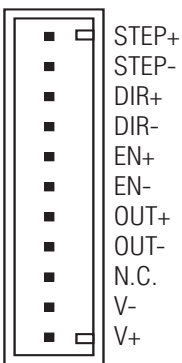

Mating Cable Diagram



Internal Circuit Diagram

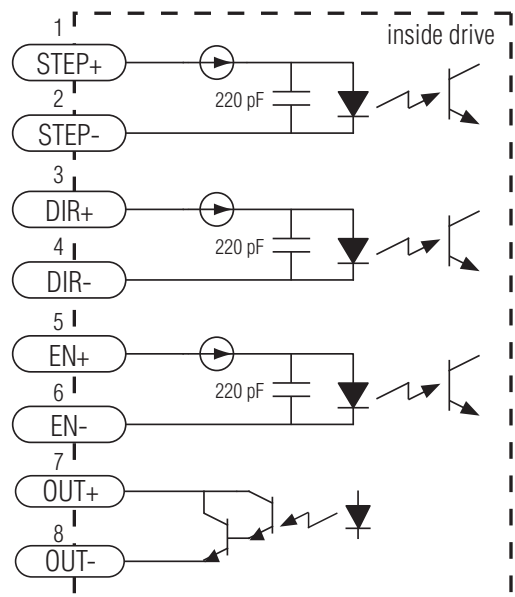

Connection Examples: STEP & DIR

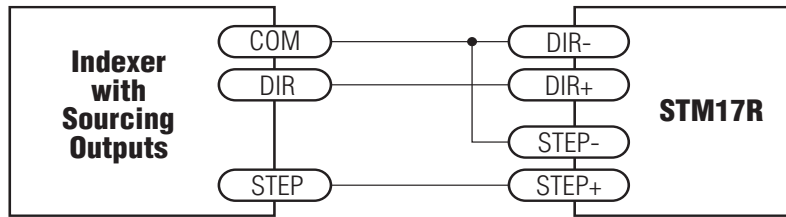

Connecting to indexer with Sourcing Outputs

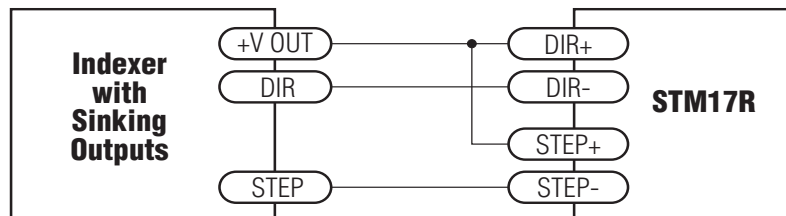

Connecting to Indexer with Sinking Outputs

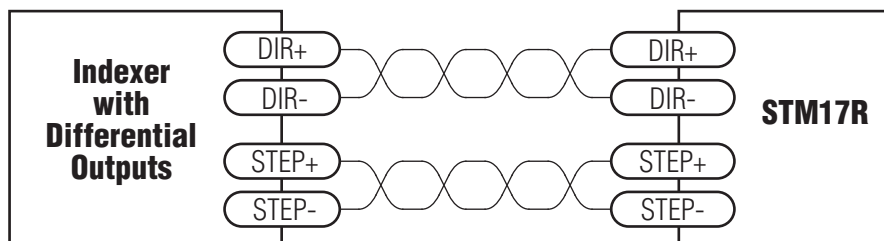

Connecting to Indexer with Differential Outputs
(Many High Speed Indexers have Differential Outputs)

Connection Examples: EN

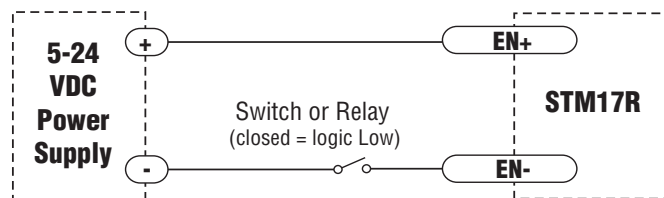

Connecting an Input to a Switch or Relay

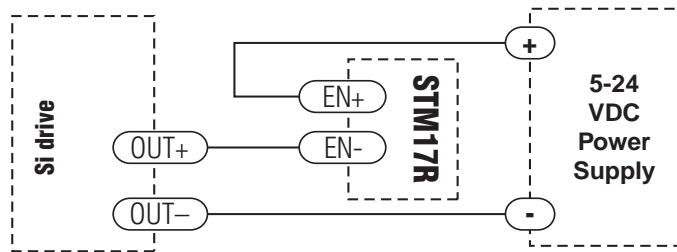

Connecting another drive to EN
(When output closes, input closes)

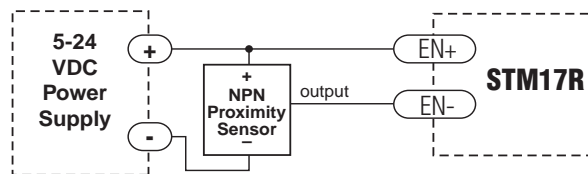

Connecting an NPN Type Proximity Sensor to an input
(When prox sensor activates, input closes)

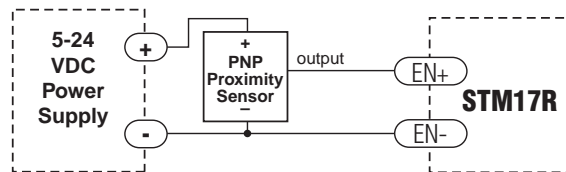

Connecting a PNP Type Proximity Sensor to an input
(When prox sensor activates, input closes)

Connecting the Digital Output

The STM17R features a digital output labeled OUT. This output closes to signal a fault condition.

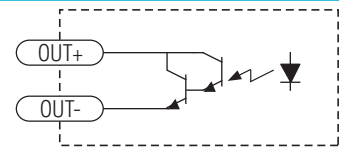

This output can be used to drive LEDs, relays and the inputs of other electronic devices like PLCs. The "+" (collector) and "-" (emitter) terminals of the output transistor are available at the connector. This allows you to configure the output for current sourcing or sinking.

Diagrams of each type of connection follow.



**Do not connect the output to more than 30VDC.
The current through the output terminal must not exceed 80 mA.**

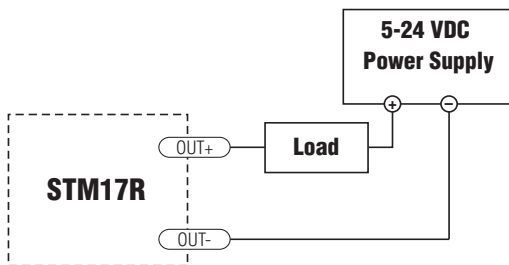

Sinking Output

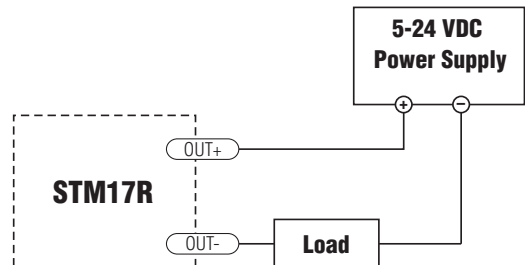

Sourcing Output

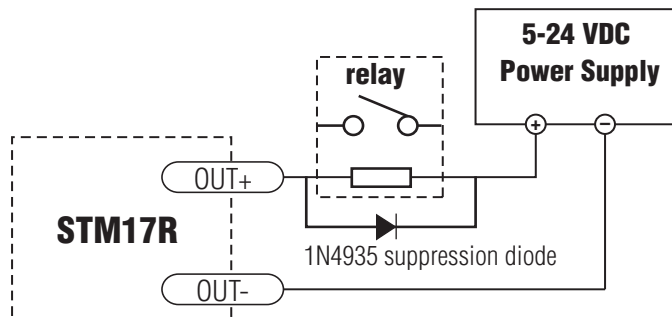

Driving a Relay

Using the Optional Encoder

The STM17R-3NE comes with a 1000-line, incremental encoder assembled to the rear shaft of the unit. The A, B and Index (Z) channel signals of this encoder can be connected back to the external controller for position verification and enhanced performance, depending on the features of the controller. To facilitate connecting the encoder signals to your external controller you should purchase cable part number 3004-263. The version of the STM17R with just the rear shaft but no encoder is the STM17R-3ND, and the single-shaft version is the STM17R-3NN.

Incremental encoder specifications:

- 10-pin connector provides the following signals (pin assignments): Ground (1, 2), Index- (3), Index+ (4), A- (5), A+ (6), +5VDC power (7, 8), B- (9) and B+ (10).
- Power supply requirements: 5 VDC at 56 mA typical, 59 mA max.
- The encoder's internal differential line driver (26C31) can source and sink 20 mA at TTL levels. The recommended receiver is industry standard 26C32.
- Maximum noise immunity is achieved when the differential receiver is terminated with a 110-ohm resistor in series with a .0047 microfarad capacitor placed across each differential pair. The capacitor simply conserves power; otherwise power consumption would increase by approximately 20mA per pair, or 60mA for 3 pairs.
- If making your own cable to connect the encoder signals to your controller, we recommend using a shielded cable with four or five twisted pairs for improved noise immunity.
- Max encoder frequency is 100,000 cycles per second.

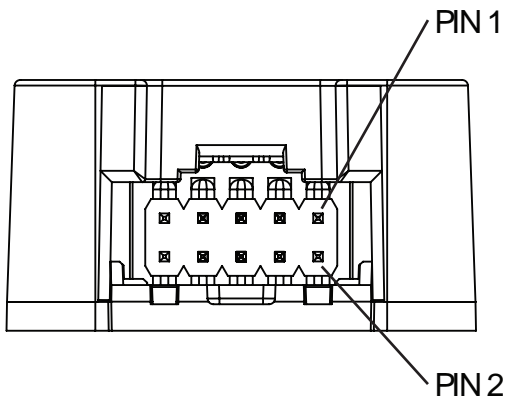

Configuring the STM17R

Step 1: Setting the Current

To achieve maximum torque, you should set the current to 100%. But under some conditions you may want to reduce the current to save power or lower motor temperature. This is important if the motor is not mounted to a surface that will help it dissipate heat or if the ambient temperature is expected to be high.

Step motors produce torque in direct proportion to current, but the amount of heat generated is roughly proportional to the square of the current. If you operate the motor at 90% of rated current, you'll get 90% of the rated torque. But the motor will produce approximately 81% as much heat. At 70% current, the torque is reduced to 70% and the heating to about 50%.

Two of the small switches on the front of the STM17R are used to set the percent of rated current that will be applied to the motor: SW1 and SW2. Please set them according to the illustration below.

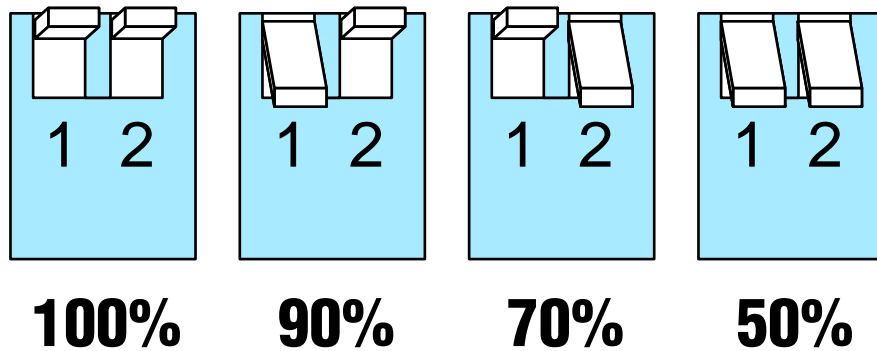

Step 2: Setting Idle Current

Motor heating and power consumption can also be reduced by lowering the motor current when it is not moving. The STM17R will automatically lower the motor current when it is idle to either 50% or 90% of the running current. The 50% idle current setting will lower the holding torque to 50%, which is enough to prevent the load from moving in most applications. This reduces motor heating by 75%. In some applications, such as those supporting a vertical load, it is necessary to provide a high holding torque. In such cases, the idle current can be set to 90% as shown.

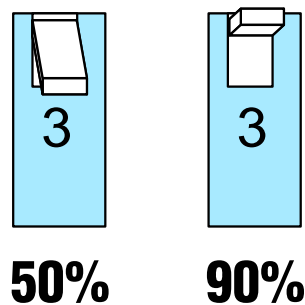

Step 3: Load Inertia

The STM17R includes anti-resonance and electronic damping features which greatly improve motor performance. To perform optimally, the drive must understand the electromechanical characteristics of the motor and load. Most of this is done automatically when the motor and drive are assembled at the factory. To further enhance performance, you must set a switch to indicate the approximate inertia ratio of the load and motor. The ranges are 0 to 4X and 5 to 10X. Please divide your load inertia by the STM17R rotor inertia (82 g-cm^2) to determine the ratio, then set switch 7 accordingly, as shown. For assistance in calculating the load inertia of your application contact our Applications department.

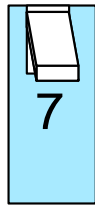
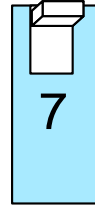
**5-10X****0-4X****Step 4: Step Size**

The STM17R requires a source of step pulses to command motion. This may be a PLC, an indexer, a motion controller or another type of device. The only requirement is that the device be able to produce step pulses whose frequency is in proportion to the desired motor speed, and be able to smoothly ramp the step speed up and down to produce smooth motor acceleration and deceleration.

Smaller step sizes result in smoother motion and more precise speed, but also require a higher step pulse frequency to achieve maximum speed. The smallest step size is $1/25,000$ th of a motor turn. To command a motor speed of 50 revolutions per second (3000 rpm) the step pulses frequency must be $50 \times 25,000 = 1.25 \text{ MHz}$. Many motion devices, especially PLCs cannot provide step pulses at such a high speed. If so, the drive must be set for a lower number of steps per revolution. Sixteen different settings are provided, as shown in the table on the previous page.

Please choose the one that best matches the capability of your system.

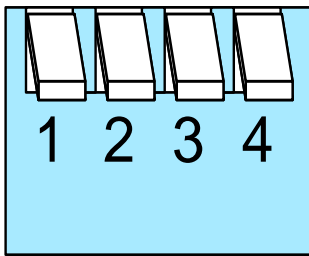

200

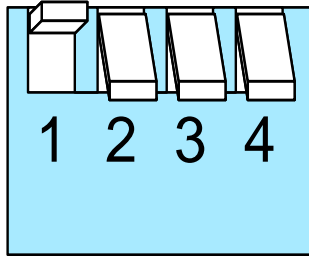

400

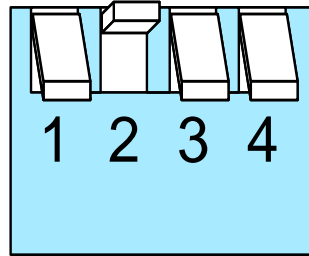

800

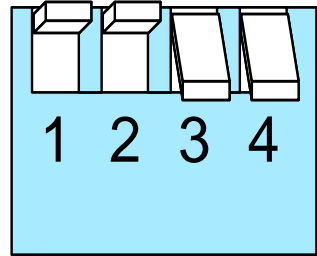

1600

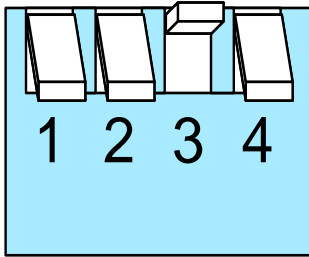

3200

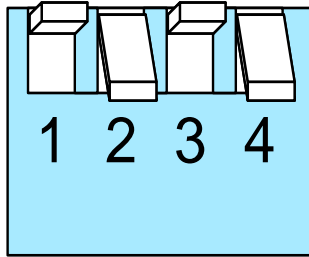

6400

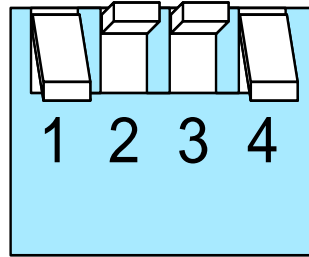

12800

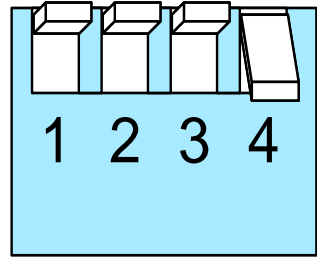

25600

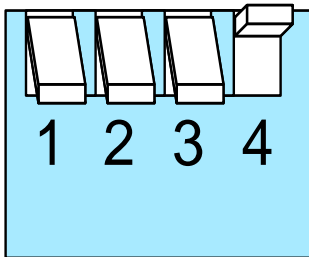

1000

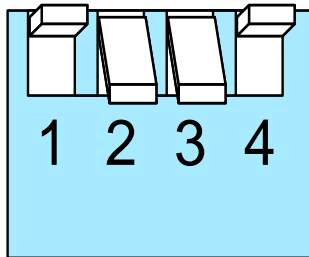

2000

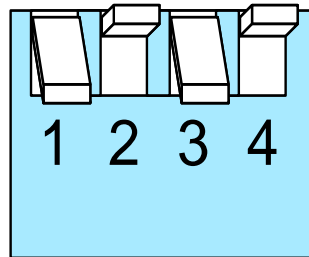

4000

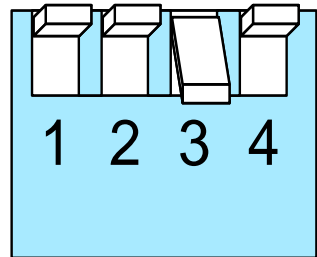

5000

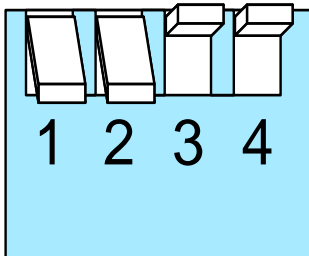

8000

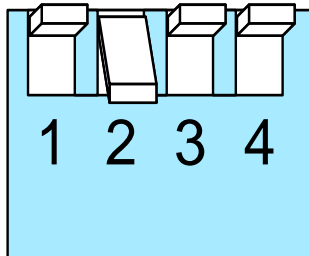

10000

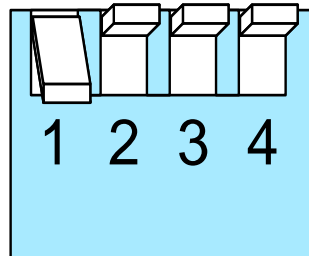

20000

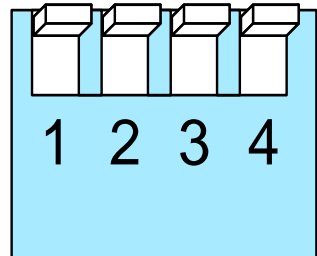

25000

At lower step resolutions such as 200 steps/ rev (full step) and 400 steps/rev (half step), motors run a little rough and produce more audible noise than when they are micro-stepped (2000 steps/rev and beyond). The STM17R includes a feature called “microstep emulation”, also called “step smoothing”, that can provide smooth motion from coarse command signals. If you set switch 6 to the ON position, this feature is automatically employed to provide the smoothest possible motion from a less than ideal signal source.

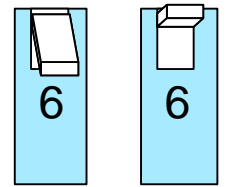

ON OFF
SMOOTHING

Because a command filter is used as part of the step smoothing process, there will be a slight delay, or “lag” in the motion. The graph below shows an example of the delay that can occur from using the step smoothing filter.

Motion Profile with Step Smoothing Filter

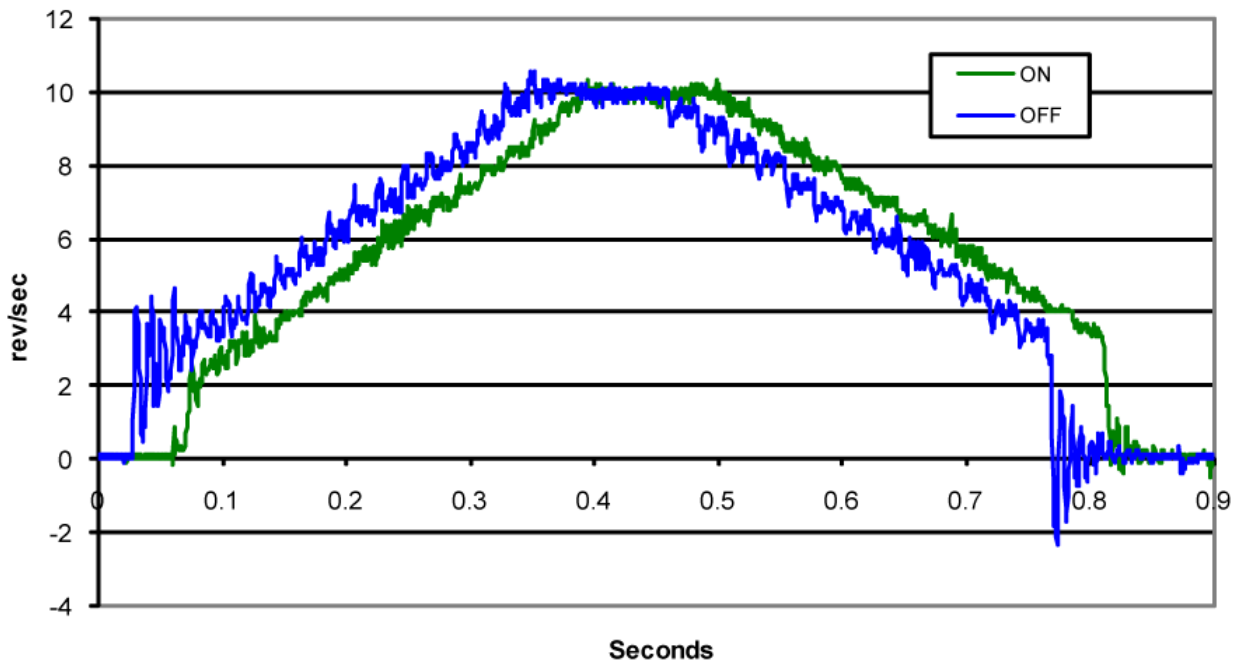

Step 5: Step Pulse Type

Most indexers and motion controllers provide motion commands in the “Step and Direction” format. The Step signal pulses once for each motor step and the direction signal commands direction. However, a few PLCs use a different type of command signal: one signal pulses once for each desired step in the clockwise direction (called STEP CW), while a second signal pulses for counterclockwise motion (STEP CCW). The STM17R can accept this type of signal if you adjust switch 8 as shown in the diagram. In STEP CW/STEP CCW mode, the CW signal should be connected to the STEP input and the CCW signal to the DIR input.

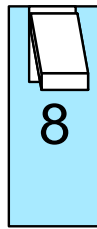

**STEP CW/
STEP CCW**

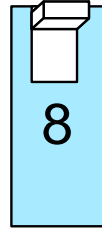

**STEP/
DIR**

Step 6: Step Pulse Noise Filter

Just when you thought there couldn't be any more to know about step signals, we present one more setting for your consideration. Electrical noise can affect the STEP signal in a negative way, causing the drive to think that one step pulse is two or more pulses. This results in extra motion and inaccurate motor and load positioning. To combat this problem, the STM17R includes a digital noise filter on the STEP and DIR inputs. The default factory setting of this filter is 150 kHz, which works well for most applications. This is set by moving switch 5 to the ON position.



**150
KHZ**

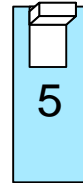

**2.0
MHZ**

However, as discussed in Step 4, if you are operating the STM17R at a high number of steps/rev and at high motor speeds, you will be commanding the drive at step rates above 150 kHz. In such cases, you should set switch 5 to the OFF position as shown below.

Your maximum pulse rate will be the highest motor speed times the steps/rev. For example, 40 revs/second at 20,000 steps/rev is $40 \times 20,000 = 800$ kHz. Please consider this when deciding if you must increase the filter frequency.

Self Test

If you are having trouble getting your motor to turn, you may want to try the built-in self test. Anytime switch 4 is moved to the ON position, the drive will automatically rotate the motor back and forth, two and a half turns in each direction. This feature can be used to confirm that the motor is correctly wired, selected and otherwise operational.

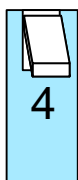

ON

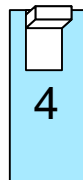

OFF

SELF TEST

Reference Materials

Torque-Speed Curves

STM17R-3 Torque at 1.8 A/phase

12V 24V 48V

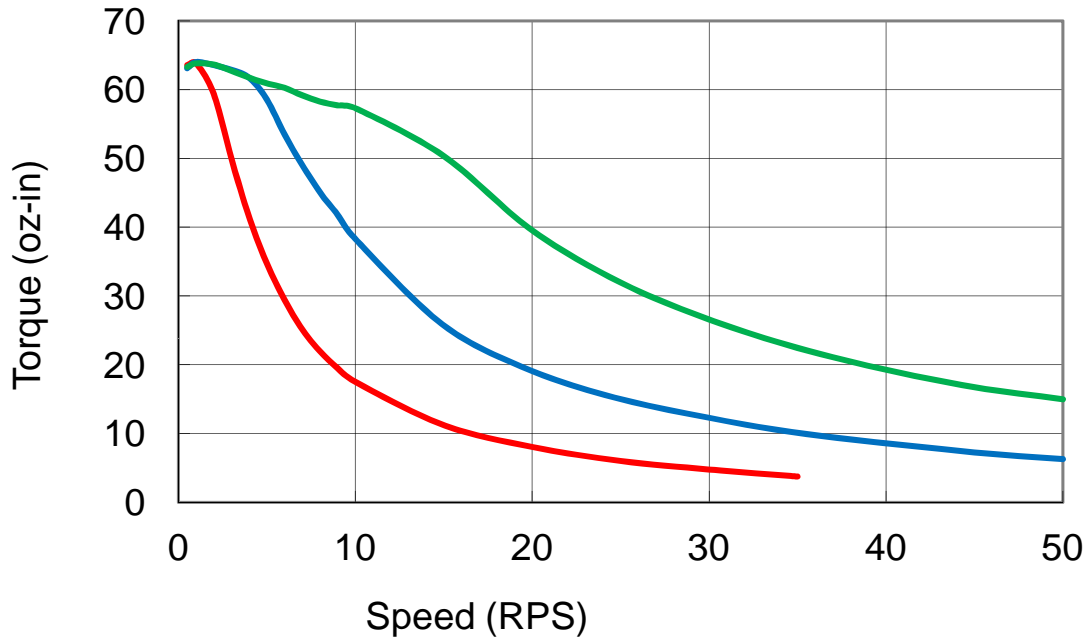

Heating

Step motors convert electrical power from the driver into mechanical power to move a load. Because step motors are not perfectly efficient, some of the electrical power turns into heat on its way through the motor. This heating is not so much dependent on the load being driven but rather the motor speed and power supply voltage. There are certain combinations of speed and voltage at which a motor cannot be continuously operated without damage.

The drive electronics of the STM17R also dissipate power. The heat produced by the electronics is dependent on power supply voltage and motor speed.

We have characterized the STM17R in our lab and provided curves showing the maximum duty cycle versus speed for each motor at commonly used power supply voltages. Please refer to these curves when planning your application. Charts depicting typical power dissipation are also provided for use in planning the thermal design of your application.

Please also keep in mind that a step motor typically reaches maximum temperature after 30 to 45 minutes of operation. If you run the motor for one minute then let it sit idle for one minute, that is a 50% duty cycle. Five minutes on and five minutes off is also 50% duty. However, one hour on and one hour off has the effect of 100% duty because during the first hour the motor will reach full (and possibly excessive) temperature.

The actual temperature of the motor depends on how much heat is conducted, convected or radiated out of it. Our measurements were made in a 40°C (104°F) environment with the motor mounted to an aluminum plate sized to provide a surface area consistent with the motor power dissipation. Your results may vary.

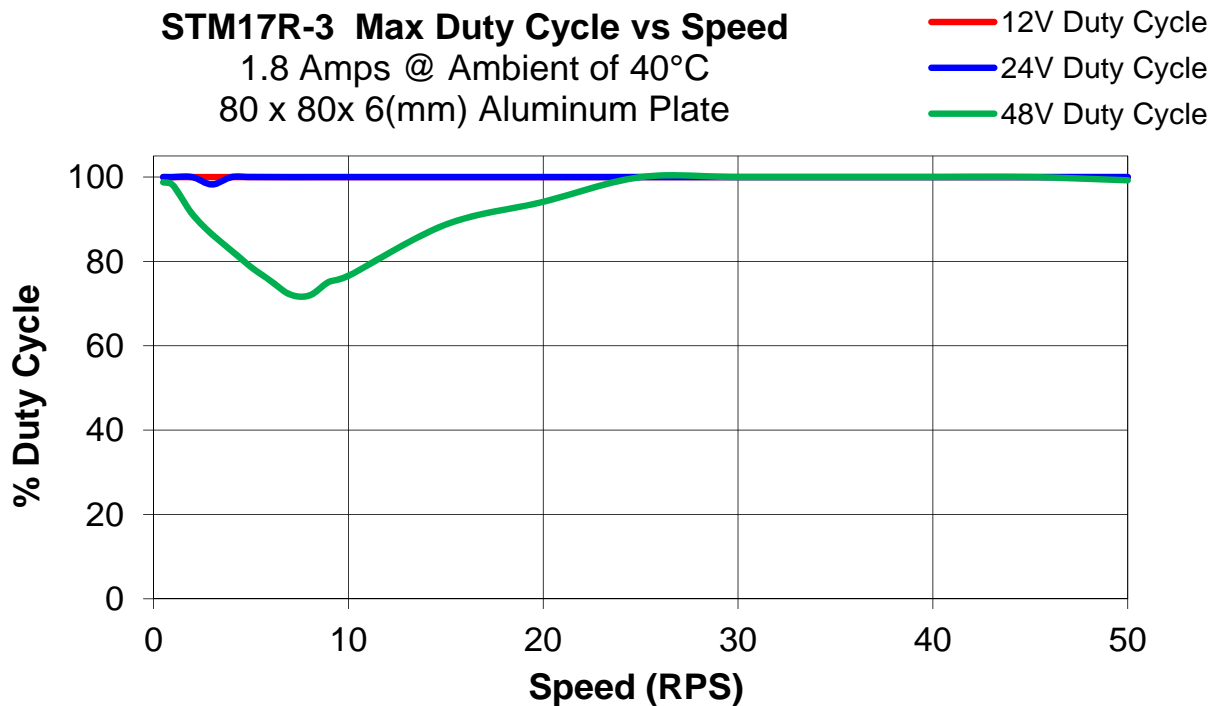

STM17R-3 Power Consumption

1.8A/phase, Full Load

— 12V — 24V — 48V

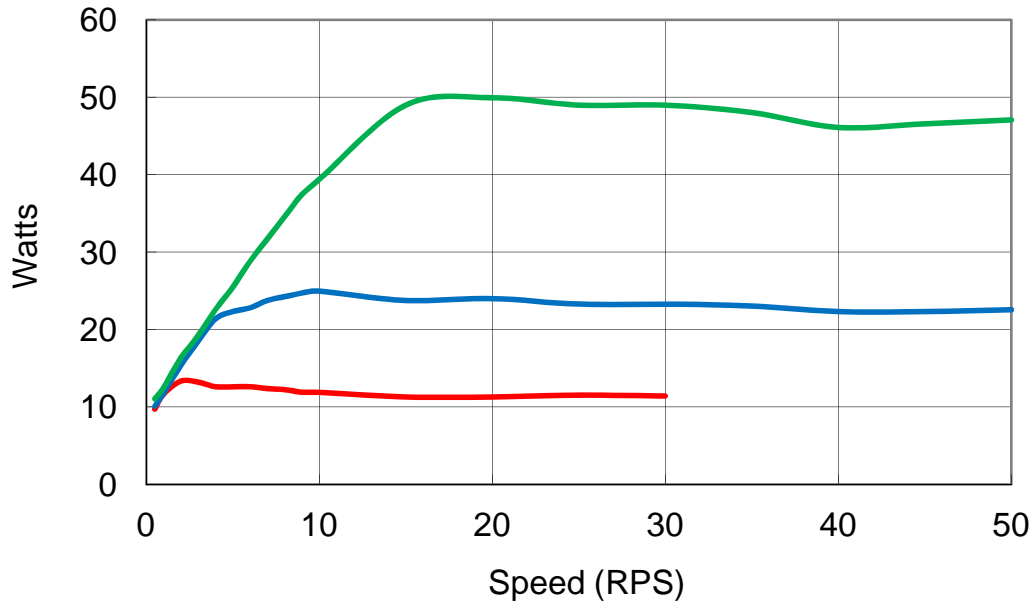

STM17R-3 Power Dissipation

1.8A/phase, Full Load

— 12V — 24V — 48V

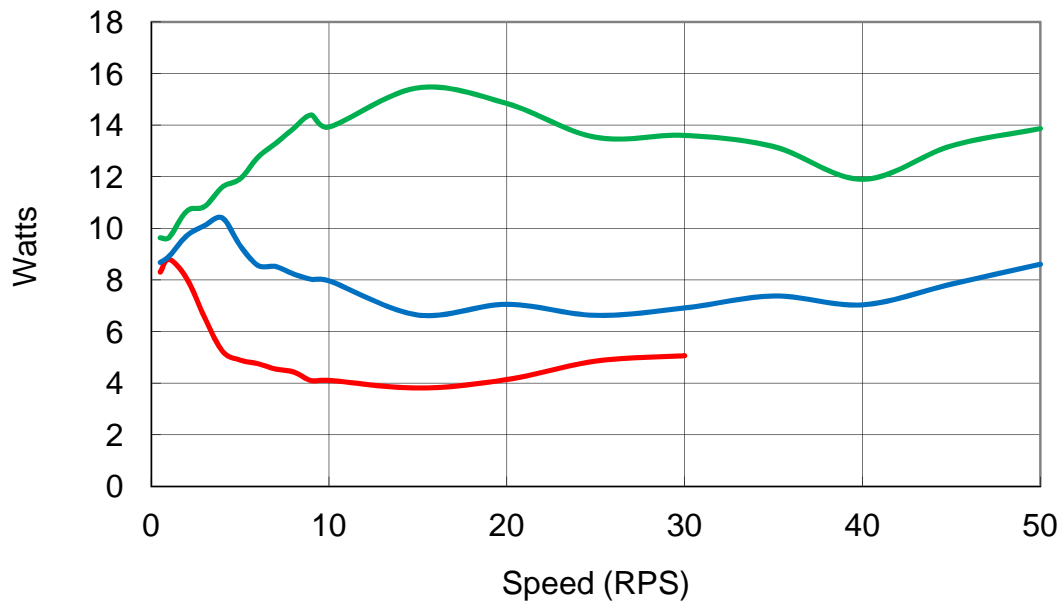

Mechanical Outlines

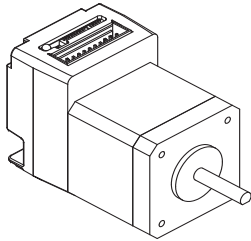

STM17R-3NN

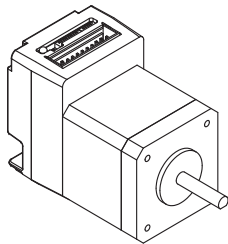
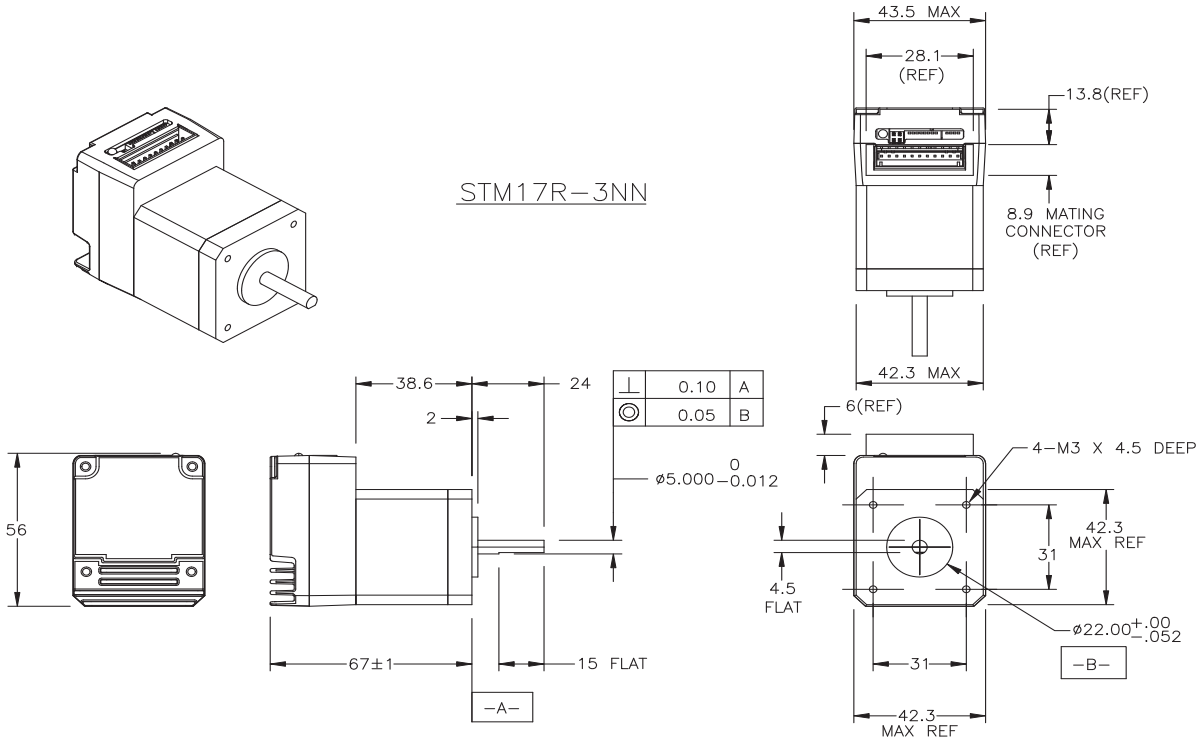

STM17R-3ND

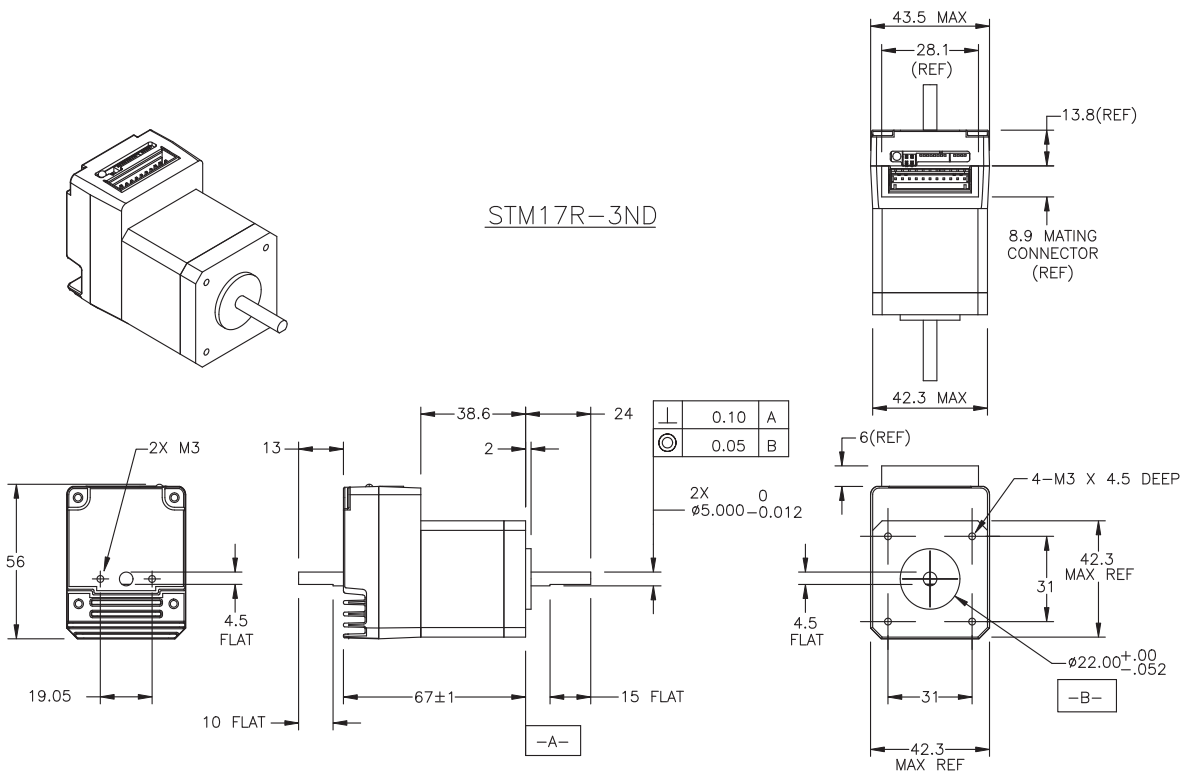

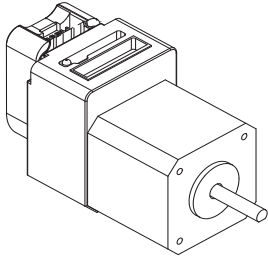

STM17R-3NE

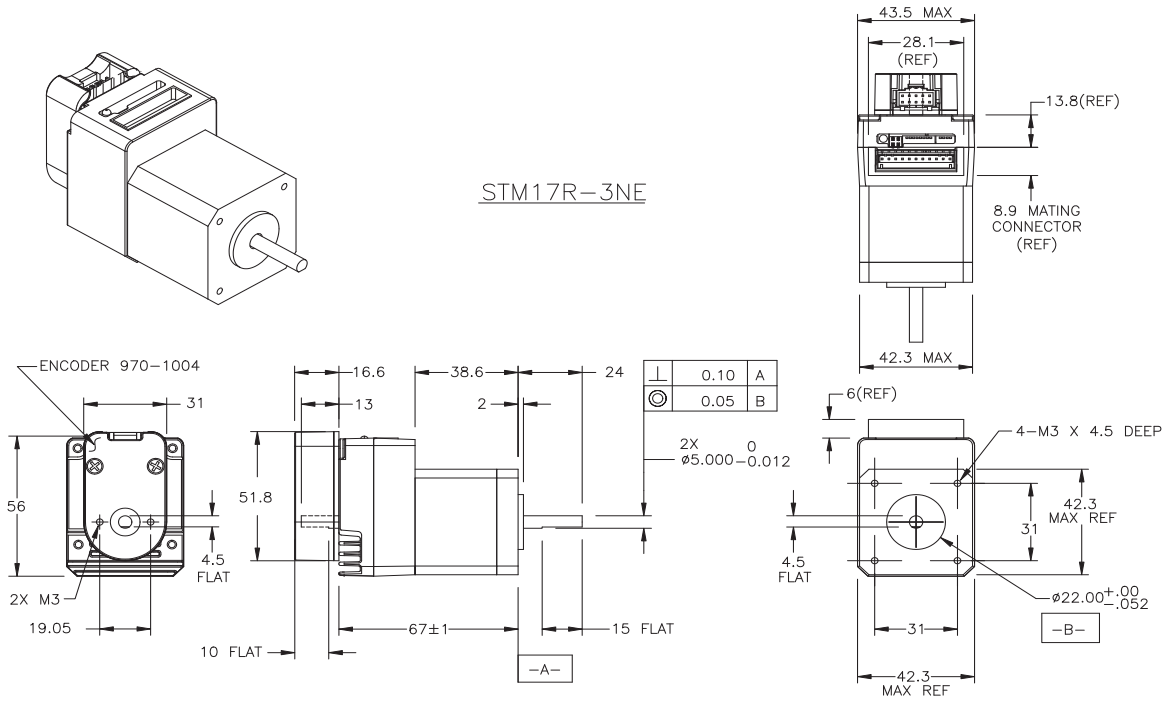

Technical Specifications

Amplifier	Digital MOSFET. 16 kHz PWM. Protection: Over-voltage, under-voltage, over-current, over-temp. Supply voltage: 12-48 VDC Under-voltage alarm: 10 VDC Over-voltage shutdown: 53 VDC Over-temp shutdown: 85°C Motor current: 1.0 to 2.0 amps/phase peak of sine (four settings via DIP switches)
Digital Inputs	Optically isolated, 5 - 24V logic. Sourcing, sinking or differential signals can be used. Drive steps on falling edge of STEP+ input. Minimum "on" voltage: 4 VDC. Maximum voltage: 30 VDC. Input current: 5 mA typ at 4V, 15 mA typ at 30V. Maximum pulse frequency: 150 kHz or 2 MHz (switch selectable) Minimum pulse width: 3 usec (at 150 kHz setting) 0.25 usec (at 2 MHz setting)
Fault Output	Photodarlington, 80 mA, 30 VDC max. Voltage drop: 1.2V max at 80 mA.
Physical	1.71 x 2.20 x 2.64 inches (43.5 x 56 x 67 mm) overall (not including pilot or shaft). 14.7 oz (416 g) 5 mm shaft with flat. Rotor inertia: 1.16×10^{-3} oz-in-sec ² (82 g-cm ²). Ambient temperature range: 0°C to 40°C.

Mating Connectors and Accessories

Mating Connector

11-Pin MTA-100 style connector with flying leads, included with drive.

Connector housing part number: Tyco 4-643498-1

Connector cover part number: Tyco 1-643075-1

Wire gauge: AWG22.

Pin numbers and wire colors:

(1)STEP+	(2)STEP-	(3)DIR+	(4)DIR-	(5)EN+	(6)EN-	(7)OUT+	(8)OUT-	(9)N.C.	(10)V-	(11)V+
ORANGE	BROWN	YELLOW	GREEN	BLUE	PURPLE	GRAY	WHITE	WHITE/GREEN	BLACK	RED

Accessories

Regeneration Clamp:

Applied Motion Products [RC-050](#).

Power Supplies:









Applied Motion Products [PS320A48 \(48VDC, 6.7A\)](#).

Applied Motion Products [PS150A24 \(24VDC, 6.3A\)](#).

Applied Motion Products [PS50A24 \(24VDC, 2.1A\)](#).

Alarm Codes

In the event of a drive fault or alarm, the green LED will flash one or two times, followed by a series of red flashes. The pattern repeats until the alarm is cleared.

Code	Error
 solid green	no alarm, motor disabled
 flashing green	no alarm, motor enabled
 flashing red	configuration or memory error
 3 red, 1 green	drive overheating
 3 red, 2 green	internal voltage out of range
 4 red, 1 green	power supply voltage too high
 4 red, 2 green	power supply voltage too low
 5 red, 1 green	over current / short circuit
 6 red, 1 green	open motor winding

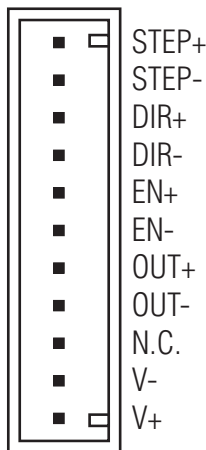

Connector Diagram

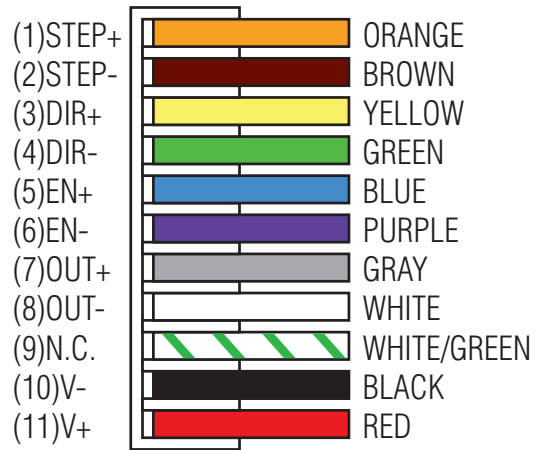

Mating Cable



404 Westridge Drive Watsonville, CA 95076
 Tel (831) 761-6555 (800) 525-1609 Fax (831) 761-6544
www.applied-motion.com