

User's Manual

PDO 2035

Step Motor Driver

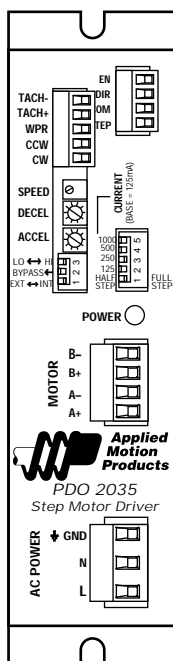

Do I Have the Right Manual?

In April, 1999 we began shipping PDO 2035 drives. Prior to that, we made a similar drive called the PD2035. The PDO 2035, which is the subject of this manual, sports the following improvements:

- Connections to the Enable input, the external speed input or the TACH output used to require a "crimped on" connector, which our customers found to be complicated and difficult. We now use pluggable, screw terminal connectors for everything.
- The Step, Dir and Enable inputs now support 5-24V signal levels without adding dropping resistors or setting the old "5V/24V switch." You can also use sourcing (PNP) or sinking (NPN) input signals. The PD2035 only accepted sinking signals.

So Which Drive Do I Have?

Just look at the front panel: it either reads "PDO 2035" or "PD2035".

If you have a PD2035, call or fax the factory and request the "PD2035 User's Manual". You can also download the manual, in Adobe PDF format, from our website at www.applied-motion.com.

Introduction

Thank you for selecting an Applied Motion Products motor control. We hope our dedication to performance, quality and economy will make your motion control project successful.

If there's anything we can do to improve our products or help you use them better, please call or fax. We'd like to hear from you. Our phone number is (800) 525-1609 or you can reach us by fax at (831) 761-6544.

Features

- Built in 30 volt DC power supply. Drive accepts AC input, 110/220 V, 50/60Hz
- Drives sizes 14 through 23 step motors. Can also be used to drive size 34 motors at low speeds.
- Pulse width modulation, recirculating switching amplifiers
- Phase current from 0.125 to 2.0 amps (switch selectable, 16 settings)
- Step, direction, amplifier enable inputs, tach output, all optically isolated
- Full and half step (switch selectable)
- Automatic 50% idle current reduction (defeatable by internal jumper)
- Built in ramping pulse generator with adjustable speed, accel, decel
- Two speed ranges: 10 - 1200 Hz and 100 - 12000 Hz
- Pluggable, screw terminal connectors
- Fully enclosed in ventilated steel housing with aluminum heat transfer plate

Block Diagram

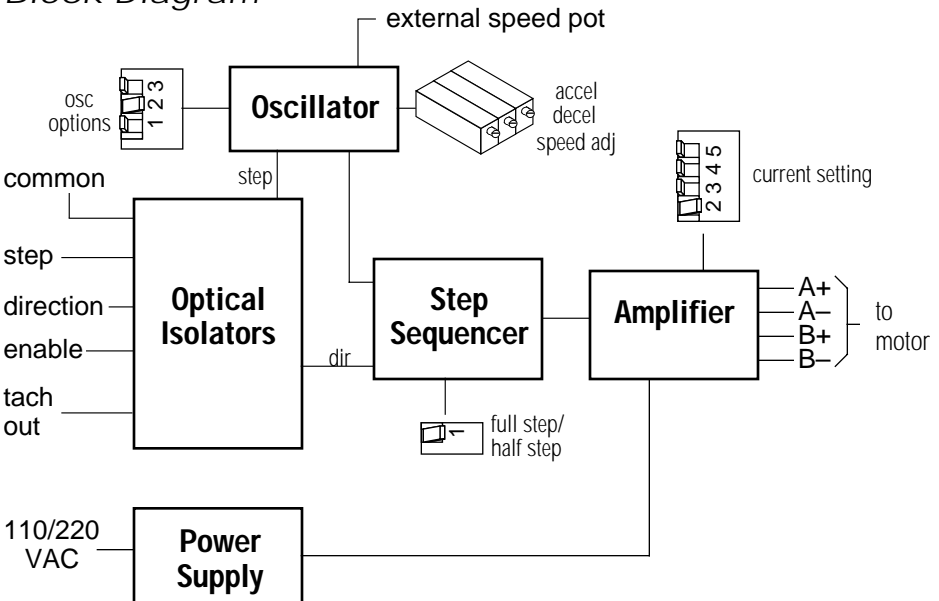

Getting Started

To use your Applied Motion Products motor control, you will need the following:

- an AC power cord
- 5-24 volts DC to activate the optoisolation circuits
- a source of step pulses
- if your application calls for bidirectional rotation, you'll also need a direction signal
- a compatible step motor (minimum inductance of 1 mH/phase)
- a small flat blade screwdriver (2.5 mm) for tightening the connectors and adjusting the oscillator
- If your application calls for connection to 220 VAC, you will need a small Phillips screwdriver in order to remove the drive cover.

Always disconnect AC power to the drive before removing the cover.

The sketch below shows where to find the important connection and adjustment points. Please examine it now. **All mating connectors are included.**

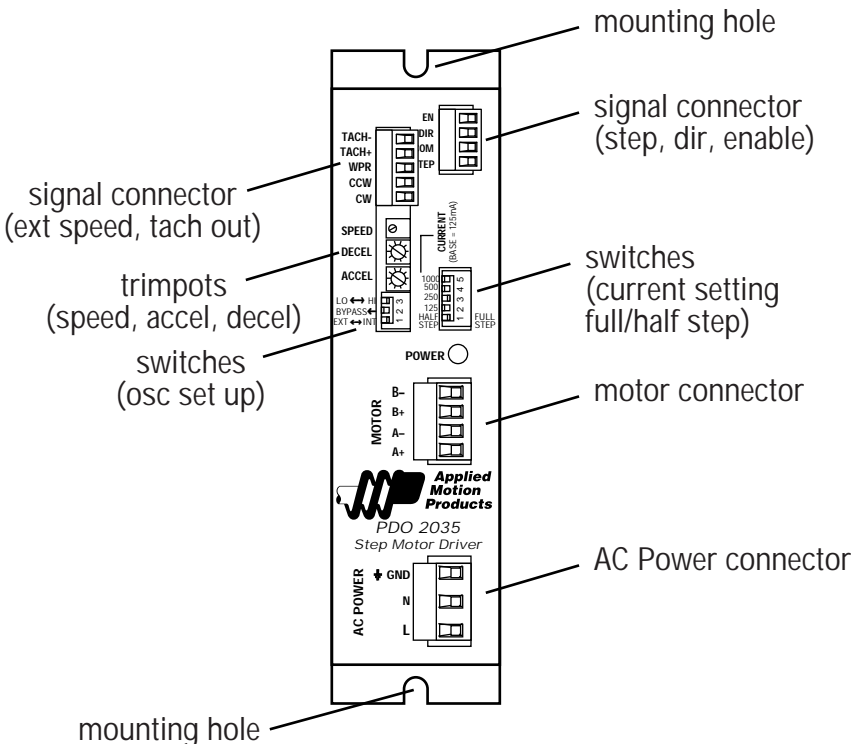

Connecting the AC Line

110 Volts

The PDO 2035 is set for 110 volt operation at the factory. All you need to do is install a power cord and plug it in. If you want to direct wire the PDO 2035 to AC power, you must consult a qualified electrician and observe all building and electrical codes.

You can install the AC cord yourself, but be careful: *AC power can be dangerous.*

220 Volts

The PDO 2035 is set for 110 volt operation at the factory. In order to use 220 volts, you'll need to remove the cover and slide the switch to the "220V" setting.

First, disconnect all power from the system. Next, remove all four of the green connector plugs from the front panel. Then, using your small Phillips screw driver, remove the five screws that hold the cover on.

The cover will slide off easily once all of the screws are removed. You should see a black switch near the "AC POWER" connector, right next to the big transformer. Push the switch to the "220V" side.

Now put the cover back on and replace all five screws, tightening them carefully.



Never operate the drive with the cover off

Installing an AC Line Cord

Remove about 5 mm (3/16 inches) of insulation from each of the three wires of your line cord. (That's right, three wires. For safety, always use a three wire power cord on anything with a metal case.) Depending on where you got your power cord, it may have black, white and green wires or brown/blue/green.

The AC power plug that was shipped with your PDO 2035 might be one of two types. The "old style" is shown below, on the left. The "new style" (shown on the right) comes with an insulating rubber boot. **Make sure you follow the proper sketch for your connector style.**

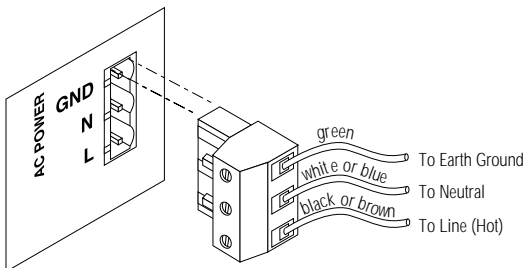

"Old Style" AC Power Plug

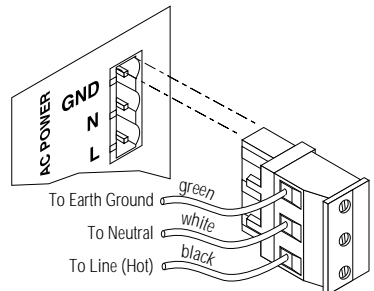

"New Style" AC Power Plug



Always unplug the line cord from the wall before attaching it to the PDO 2035

- Connect the black or brown wire to the PDO 2035 "L" terminal of the AC power connector. That is the line, or "hot" connection.
- Connect the white or blue wire to neutral. That's the "N" terminal.
- Finally, and most importantly, connect the green wire to the GND terminal. That connects the PDO 2035 metal enclosure and DC power supply ground to earth ground.

Connecting the Motor



Never connect the motor to the driver when the AC power is on. Secure any unused motor leads.

Never disconnect the motor while the AC power is on.

Never connect motor leads to ground or to a power supply.

You must now decide how to connect your motor to the drive.

Four lead motors can only be connected one way. Please follow the sketch at the right.

Six lead motors can be connected in series or center tap. In series mode, motors produce more torque at low speeds, but cannot run as fast as in the center tap configuration. In series operation, the motor should be operated at 30% less than the rated current to prevent overheating. Winding diagrams for both connection methods are shown below. NC means not connected.

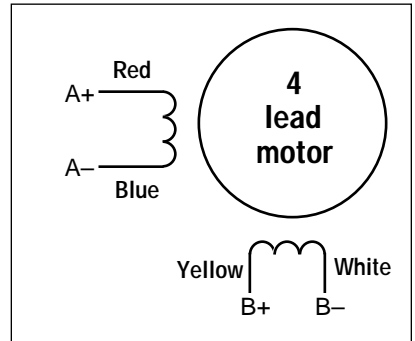

4 Leads

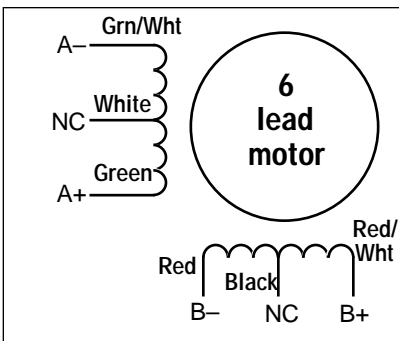

6 Leads Series Connected -6-

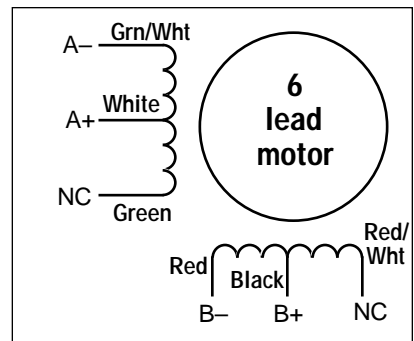

6 Leads Center Tap Connected

Eight lead motors can also be connected in two ways: series and parallel. As with six lead motors, series operation gives you more torque at low speeds and less torque at high speeds. In series operation, the motor should be operated at 30% less than the rated current to prevent over heating. The wiring diagrams for eight lead motors are shown below.

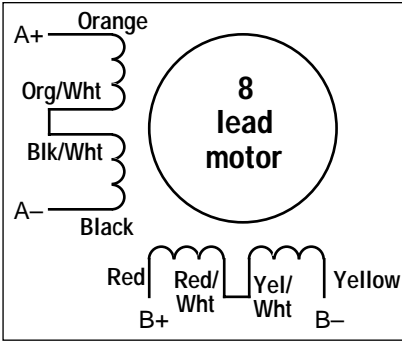

8 Leads Series Connected

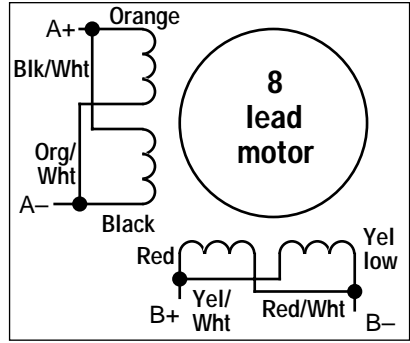

8 Leads Parallel Connected

**Step Table
(full stepping)**

Step	A+	A-	B+	B-
0	+	-	+	-
1	-	+	+	-
2	-	+	-	+
3	+	-	-	+
4	+	-	+	-

Step 3 is the Power Up State

DIR=1
CW

DIR=0
CCW

Connecting Logic

The PDO2035 drive contains optical isolation circuitry to prevent the electrical noise (inherent in switching amplifiers) from interfering with your circuits. Optical isolation is accomplished by powering the motor driver from a different supply than your circuits. There is no electrical connection between the two: signal communication is achieved by infrared light. When your circuit turns on or turns off an infrared LED (built into the PDO2035) signals a logic state to the photo-transistors that are wired to the brains of the drive.

A schematic diagram of the input circuit is shown on the right.

You must supply 5-24 volts DC to activate the LEDs on the input side of the optoisolators. The maximum current draw is 30 mA.

If your controlling logic is 24V, it must be capable of sinking at least 30 mA to control each drive input. If you are using 5 volt logic (TTL level) then each signal must sink 5 mA.

If your STEP, DIR and ENABLE signals are sinking (NPN) then connect COM to your power supply +. If your signals are sourcing (PNP) then connect COM to power supply -.

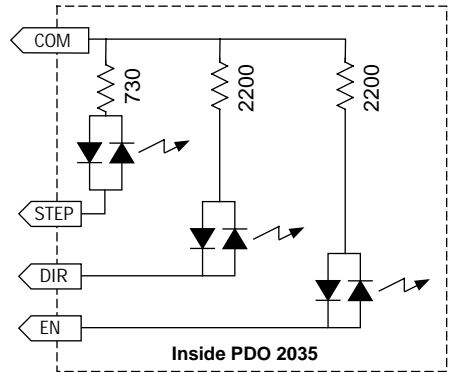

STEP tells the driver when to move the motor one step. The drive steps on the rising edge of the pulse. If the pulse is negative (low) the minimum width is 10 microseconds.

DIRECTION signals which way the motor should turn. See the step table on page 7 for details. The *DIRECTION* signal should be changed at least 50 microseconds before a step pulse is sent. **If you change the state of the direction input and send a step pulse at the same instant the motor may take a step in the wrong direction.**

ENABLE allows the user to turn off the current to the motor by setting this signal to logic 0. The logic circuitry continues to operate, so the drive "remembers" the step position even when the amplifiers are disabled. However, the motor may move slightly when the current is removed depending on the exact motor and load characteristics. **If you have no need to disable the amplifiers, you don't need to connect anything to the ENABLE input.**

Using the TACH Output

The PDO2035 has a pulse output to tell you how fast the oscillator is going. It produces one pulse per motor step. You can connect this to a counter to provide position information, or to a tachometer to provide speed data, or both. The pulse output is optically isolated for noise immunity, which makes it more flexible and more reliable, but also harder to hookup.

The TACH output is rated for 5 - 24VDC operation, up to 20 mA.

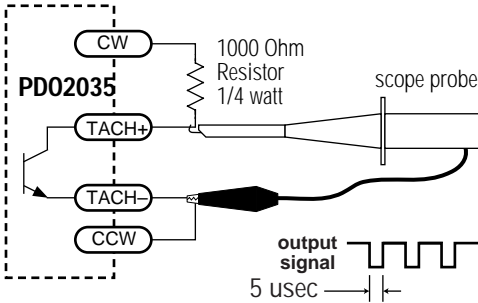

Connecting the Pulse Output to a Frequency Counter or Oscilloscope

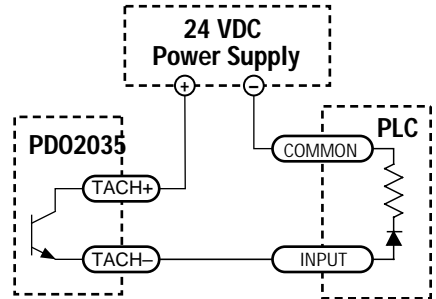

Connecting the Pulse Output to a PLC

Selecting Between Full and Half Step

Locate the bank of DIP switches on the front panel. Switch number 1 is labeled *HALF STEP*. Sliding the switch toward the *HALF STEP* label sets the driver for that mode of operation. The opposite position is full step. When set to full step, the driver always uses "two phases on" mode to provide maximum motor torque.

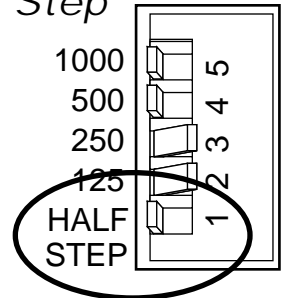

Using the Oscillator

The PDO2035 is equipped with an internal pulse generator that you can use to control the motor. To select the oscillator mode of operation (run/stop mode) move switch 2 away from the *BYPASS* label, as shown at the right.

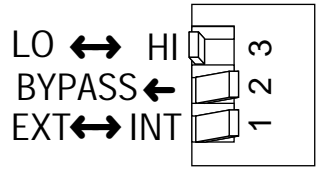

The oscillator is activated by driving the *STEP* input low. The frequency of step pulses will increase linearly, accelerating the motor until it reaches a preset slew speed. The motor will remain at this speed until the *STEP* input is driven high. The step pulse frequency then decreases linearly, decelerating the motor and load to rest. The PDO2035 lets you choose from two oscillator speed ranges: 10 - 1200 steps/second (LO) and 100 - 12000 steps/sec (HI). Set the speed range with the "LO/HI" switch.

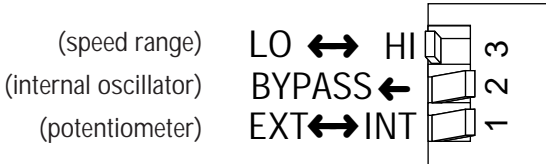

10 - 1200 steps/sec

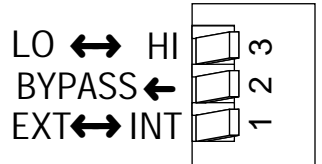

100 - 12000 steps/sec

To adjust the speed, locate the trimpot labeled *SPEED*. By turning the brass screw you can raise or lower the speed within the range you have selected. Turning the screw clockwise makes the motor run faster.

The acceleration and deceleration rates can also be adjusted using the trimpots labeled *ACCEL* and *DECEL*. The range of accel and decel rates is illustrated below. Turning the screw clockwise makes the motor accelerate or decelerate faster.

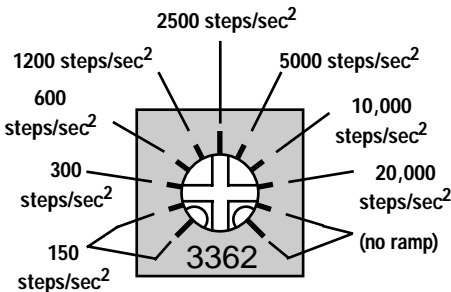

LO range accel/decel settings
Shown at 2500 steps/sec²

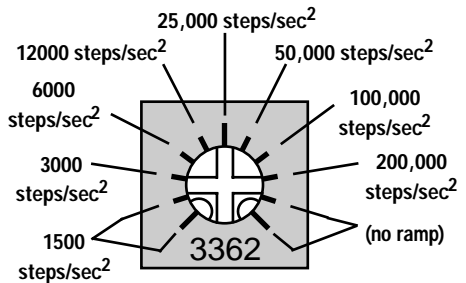

HI range accel/decel settings
Shown at 25,000 steps/sec²

Using the Oscillator with Switches & PLCs.

If you plan to use the PDO 2035 in oscillator mode, you may need a source of voltage to activate the optoisolation circuits. This is true if you are using mechanical switches or relays. It may also be the case if you are using a PLC with optically isolated outputs, since they behave like switches.

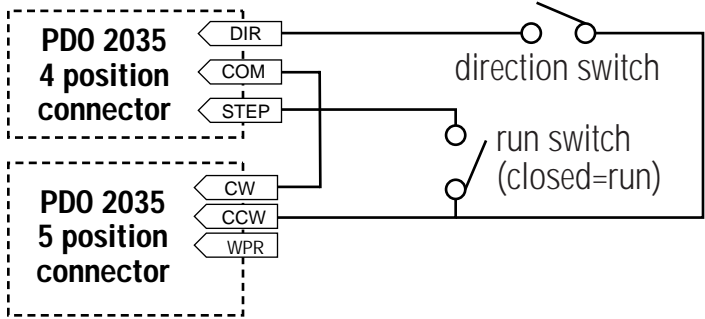

Setting Phase Current

Before you turn on the power supply the first time, you need to set the driver for the proper motor phase current. The rated current is usually printed on the motor label.

The PDO 2035 drive current is easy to set. If you wish, you can learn a simple formula for setting current and never need the manual again. Or you can skip to the table on the next page, find the current setting you want, and set the DIP switches according to the picture.

Current Setting Formula

Locate the bank of DIP switches next to the motor connector. Four of the switches have a value of current printed next to them, such as 500 and 1000. Each switch controls the amount of current, in milliamperes (mA), that its label indicates. There is always a base current of 125 mA. To add to that, slide the appropriate switches toward their labels. You may need your small screwdriver for this.

Example

Suppose you want to set the driver for 1.25 amps per phase (1250 mA). You need the 125 mA base current plus another 1000 and 125 mA.

$$1250 = 125 + 1000 + 125$$

Slide the 125 and 1000 mA switches toward the labels as shown in the figure.

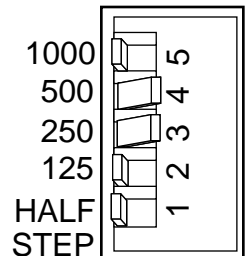

Current Setting Table

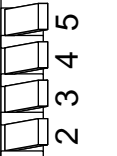
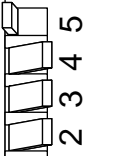
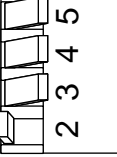
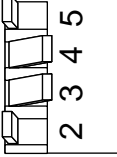
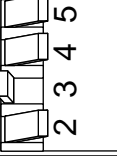
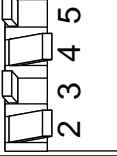
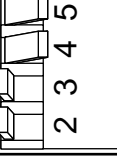
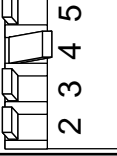
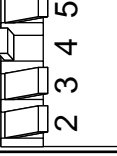
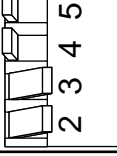
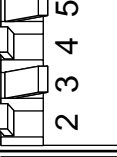
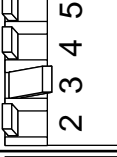
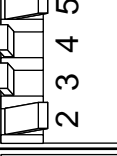
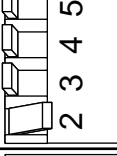
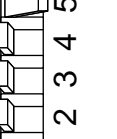
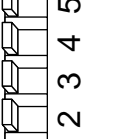
<p>.125 AMPS/PHASE</p> <p>1000 500 250 125</p> 	<p>1.125 AMPS/PHASE</p> <p>1000 500 250 125</p> 
<p>.25 AMPS/PHASE</p> <p>1000 500 250 125</p> 	<p>1.25 AMPS/PHASE</p> <p>1000 500 250 125</p> 
<p>.375 AMPS/PHASE</p> <p>1000 500 250 125</p> 	<p>1.375 AMPS/PHASE</p> <p>1000 500 250 125</p> 
<p>.5 AMPS/PHASE</p> <p>1000 500 250 125</p> 	<p>1.5 AMPS/PHASE</p> <p>1000 500 250 125</p> 
<p>.625 AMPS/PHASE</p> <p>1000 500 250 125</p> 	<p>1.625 AMPS/PHASE</p> <p>1000 500 250 125</p> 
<p>.75 AMPS/PHASE</p> <p>1000 500 250 125</p> 	<p>1.75 AMPS/PHASE</p> <p>1000 500 250 125</p> 
<p>.875 AMPS/PHASE</p> <p>1000 500 250 125</p> 	<p>1.875 AMPS/PHASE</p> <p>1000 500 250 125</p> 
<p>1 AMPS/PHASE</p> <p>1000 500 250 125</p> 	<p>2 AMPS/PHASE</p> <p>1000 500 250 125</p> 

Using Remote Speed Control Potentiometer

The PDO 2035 step motor driver includes an analog signal input connector that can be used to control the oscillator speed externally. Normally, an on board potentiometer controls the speed. Whether you use the on-board or external pots, the accel/decel ramping remains active.

You will need:

- a $1k\Omega$ - $10k\Omega$ linear potentiometer. A multiturn type is recommended.
- a shielded, three wire cable

To install the external pot:

- locate the 5 position front panel connector (marked tach+, tach-, etc)
- prepare a cable with your pot on one end and the connector on the other end:
 - the potentiometer wiper connects to the WPR terminal
 - the potentiometer CW terminal connects to the CW terminal
 - the third pot terminal connects to CCW
 - the cable shield connects to the third pot terminal

With this arrangement, speed will increase as you turn the external pot clockwise. The on board trimpots will still control acceleration and deceleration times.

Set the EXT/INT switch to EXT to select the external potentiometer.

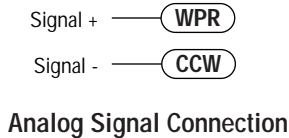
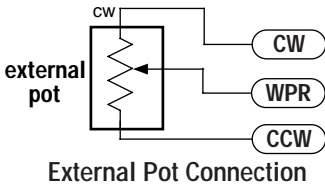

You can also use an external analog voltage to set the speed. The voltage must be between 0 and 5 VDC. Connect the voltage to the WPR pin and the voltage return to CCW. For the LO speed range, the conversion is 240 steps/sec/volt. For the HI speed range, the formula is 2400 steps/sec/volt.

If the analog voltage source generates it's own accel and decel ramps (such as a servo controller) set the ACCEL and DECEL trimpots at the "no accel/decel" setting so the oscillator does not interfere with the ramps.

Mounting the Drive

You should mount the PDO 2035 on the heat transfer plate as shown below. Use #8 or #10 screws.

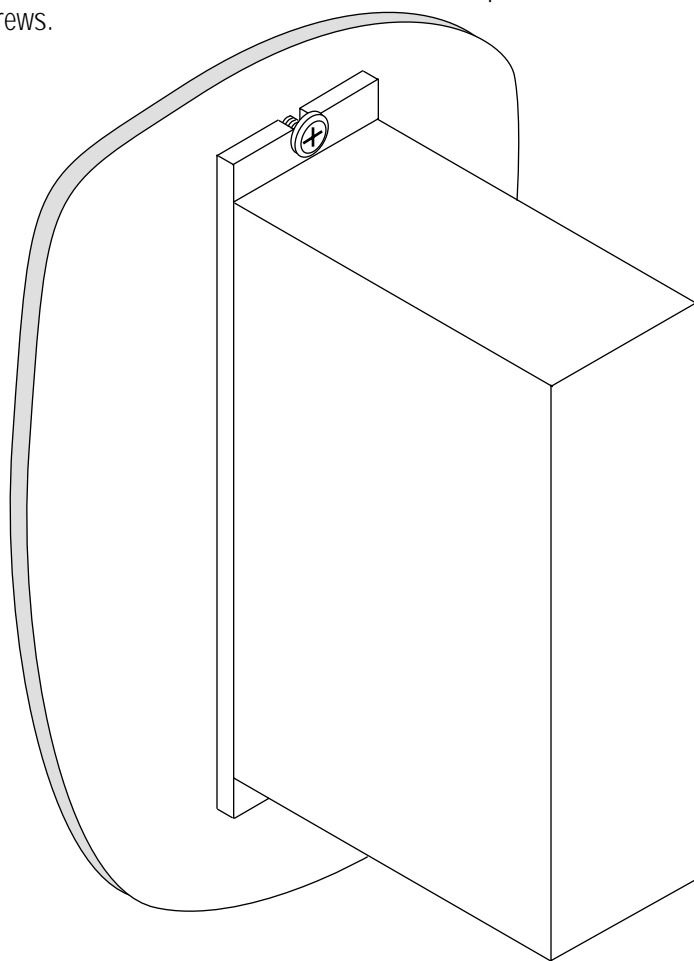

The amplifiers in the drive generate heat. Unless you are running at 1 amp or below, you may need a heat sink. To operate the PDO 2035 continuously at maximum power you must properly mount it on a heat sinking surface with a thermal constant of no more than 4°C/watt. Often, the metal chassis or enclosure of your system will work as an effective heat sink.



***Never use your drive in a space where there is no air flow
or where the ambient temperature exceeds 50°C (120°F)***

Never block the vent holes.

Never put the drive where it can get wet.

Never allow metal particles near the drive.

Technical Specifications

- Amplifiers** Dual, bipolar recirculating H-bridge, pulse width modulated switching at 20 kHz. 0.125 - 2.0 amps/phase output current, switch selectable in 0.125 A increments. 50 watts maximum output power. Automatic idle current reduction, reduces current to 50% of setting after one second. Min. motor inductance 1 mH.
- Oscillator** HI range: 100 - 12000 steps/sec range, 100 Hz resolution
LO range: 10 - 1200 steps/sec, 10 Hz resolution
Speed adjustable by 15 turn potentiometer, or user supplied external pot, or 0 - 5 volt analog signal. Linear acceleration and deceleration, individually adjustable from 750 to 200,000 steps/sec/sec, with single turn potentiometers.
- Power Supply** 110 or 220 VAC input, switch selectable. 50 - 60 Hz. 75 W max. DC voltage at nominal line voltage: 28 VDC full load, 40 VDC no load.
- Inputs** *Step*: optically isolated, 5-24V, 730 ohm input impedance. Motor steps on rising edge of step line. 10 μ sec minimum low pulse. Step input used as run/stop in oscillator mode. (closed = run, open = stop.)
Direction and Enable: optically isolated, 5-24V, 2200 ohm input impedance. 50 μ sec minimum set up time for direction signal.
- Pulse Out** Optically isolated, uncommitted (open collector, open emitter) photo transistor. 30V, 20 mA max.
- Physical** Constructed on black anodized aluminum heat transfer plate. Covered by heavy gauge ventilated steel housing. 1.75 x 4.0 x 6.8 inches overall. Power on LED. See drawing on back cover for more information. Ambient temperature range: 0 - 70°C.
- Connectors** Pluggable screw terminal blocks.
Motor: 4 position. Wire size: AWG 12-22
Signals (step, dir, enable): 4 position, AWG 16-28.
Signals (tach, external speed pot): 5 position, AWG 16-28.
AC Power: 3 position, AWG 12-22.
- Fuse** 1A UL rated, fast acting, TR5 style. Available from Digikey (800-DIGIKEY) as part number WK3048BK.

Mechanical Outline

10/2/00 PDO2035.ai

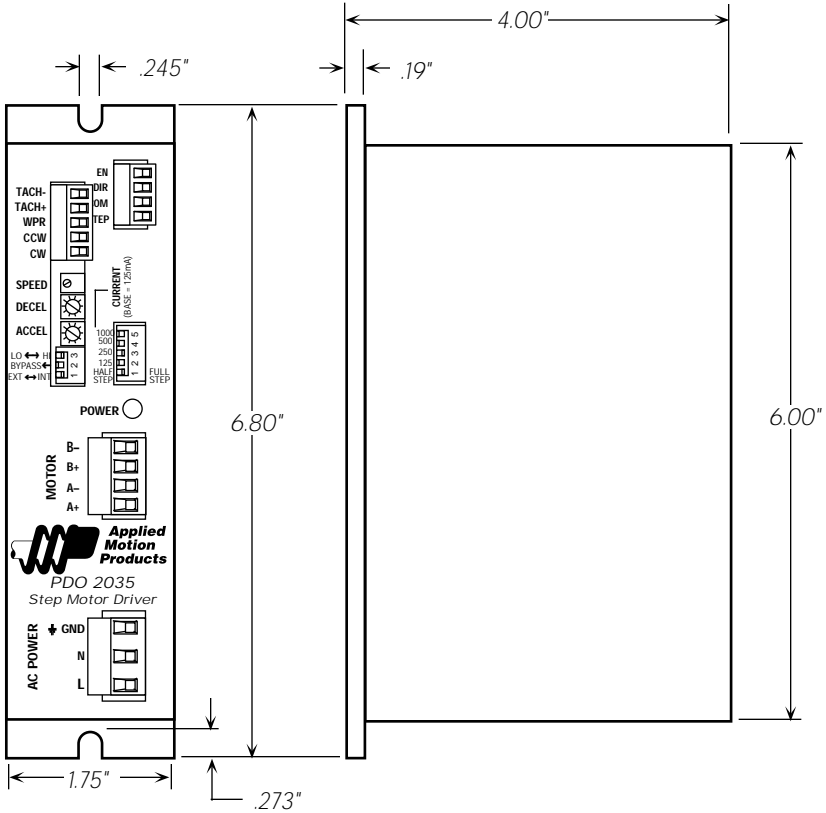

Copyright 2000

Applied Motion Products, Inc.

404 Westridge Drive Watsonville, CA 95076

Tel (831) 761-6555 (800) 525-1609 Fax (831) 761-6544