

REVISIONS				
ECO NO.	REV	DESCRIPTION	DATE	APPROVED
7466	A	INITIAL RELEASE	8/31/16	J.KORDIK

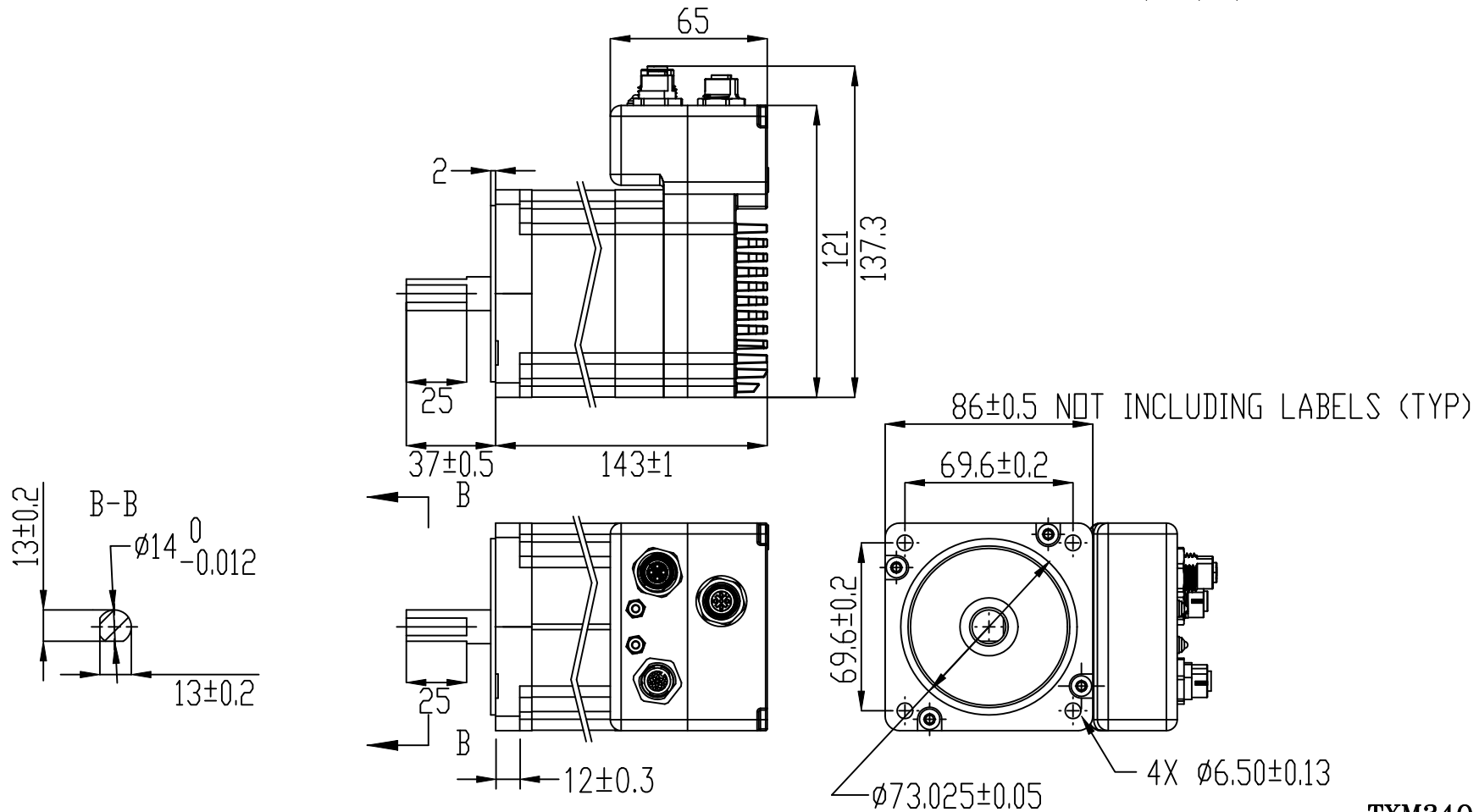

TXM34Q-3AG

TOLERANCES		THIRD ANGLE PROJECTION		APPLIED MOTION PRODUCTS, INC.	
*ALL DIMENSIONS IN MM				INTEGRATED StepSERVO MOTOR OUTLINE DRAWING	
DECIMALS: MM X.XX = ±0.13 X.X = ±0.25 ANGLES: MACH. = ±0.5° CHAM. = ±5°					
COMPUTER DATA		DRAWN	K.KESLER	7/13/16	B DWG NO. TXM34Q-3AG REV A
BASE DRAWING		CHECKED	-	-	
		APPROVED	-	-	SCALE: NONE SHEET 1 OF 1