

TOP VIEW

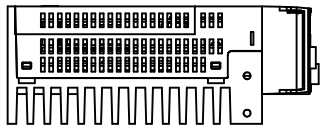

LEFT VIEW

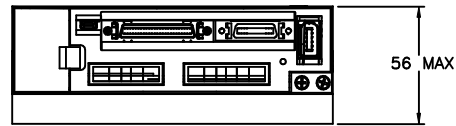

FRONT VIEW

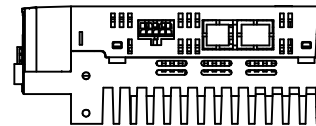

RIGHT VIEW

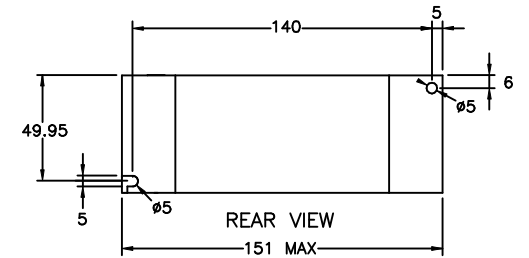

REAR VIEW

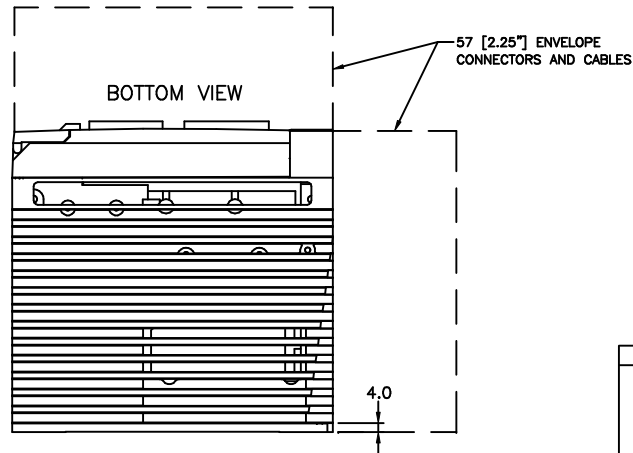

BOTTOM VIEW

REVISIONS				
REV	ECO	DESCRIPTION	DATE	APPROVED
A	7261	INITIAL RELEASE	7/23/15	J KORDIK
B	7278	CLEANUP DIMENSIONS	10/23/15	J KORDIK

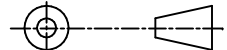
TOLERANCES		THIRD ANGLE PROJECTION		 <b>APPLIED MOTION PRODUCTS, INC.</b> <b>SV200 SERVO DRIVE</b> <b>120 VOLT, 400 WATT</b>	
DECIMALS: MM X.XXX = ±0.013 X.XX = ±0.25 X.X = ±2.5 ANGLES: MACH. = ±5° CHAM. = ±5°					
APPROVALS DRAWN <b>R. JONES</b> CHECKED DATE <b>7/23/15</b>		APPROVED		SCALE: NONE SHEET 1 OF 1	
COMPUTER DATA BASE DRAWING					