

## PDO 5580 Packaged Pulse and Direction Step Motor Drive with Digital Oscillator

### Features

- AC input 110V or 220V switch selectable, 50-60 Hz
- DC bus voltage 75 VDC full load, 80 VDC nominal
- Switch selectable motor current from 0.5–5.5 amps/phase
- Microstepping:
  - Pulse and Direction mode: switch selectable 200 to 50,800 steps/rev
  - Oscillator/Joystick mode: 12,800 steps/rev
- Switch selectable idle current reduction, 0 or 50%
- Optically isolated inputs/outputs
  - Speed, Enable: optically isolated, differential 5–24 V logic
  - Step, Direction: optically isolated, differential 5–12 V logic
  - Wiper: 0–5VDC analog signal
  - Tach & Fault output: isolated phototransistor. Output is 100 pulses per motor revolution, 50% duty cycle.
- Internal Pot:
  - Low speed 0–5 rps
  - High speed 0–25 rps
  - Accel/decel 1–250 rev/sec/sec
- External Speed, Pot or Joystick 3 terminal type, 1k–10k ohms
- Self test, switch selectable
- 440 watts of usable power
- Overtemp, overcurrent and surge protection
- Screw terminal connectors
- Dual, MOSFET H-bridge, 3 state, pulse width modulated amplifier switching at 20–30 KHz
- Ideal for 4, 6 or 8 leaded step motors NEMA sizes 23 or 34
- CE and TUV compliant

### Description

The PDO5580 is stepper drive packaged in a rugged steel case painted black with white epoxy silkscreen. Integral heat sink, mounting brackets, switch covers and connectors are included with each drive. The drive has been matched with twelve recommended NEMA 23 and 34 motors in order to create a complete stepper motion solution.

The PDO5580 provides the user with four modes of operation to choose from, Self test, Pulse & Direction, Joystick or Oscillator. The specific operation mode desired is selected during set up via DIP switch. DIP switches are also provided for setting the drive's step resolution as well as the motor current.

Self Test Mode is used for troubleshooting. If you are unsure about the motor or signal connections to the drive you can use the self-test.



Pulse & Direction Mode allows the PDO5580 to receive step pulses from an indexer such as the Applied Motion's Si-100 or Si-1, or from a PLC or any other external controller.

Joystick Mode allows speed and direction to be determined by an external analog voltage. STEP and DIR inputs can be used for limit switches. SPEED input selects speed range. LO SPEED and HI SPEED pots adjust the 2 speed ranges.

Oscillator Mode can control speed by onboard potentiometers and/or by an external analog voltage. STEP input starts and stops the motor. DIR input controls direction of rotation. SPEED input selects the speed range.

The PDO5580 also provides a Tach Output and Enable Input.

A Tach Out signal is provided for measuring the motor speed. It generates 100 pulses per revolution. If connected to a frequency counter, speed reads out in revs/second with two decimal places.

ENABLE allows the user to turn off the current to the motor by setting this signal to logic 0. The logic circuitry continues to operate, the drive "remembers" the step position even when the amplifier is disabled.

Factory set to operate at 110-volt input; the PDO5580 can be reset by the user to operate at 220-volt input by a simple switch selection.

Pluggable screw terminal blocks are provided for the motor, AC input and 8-position signal input/output. Mating connectors are provided with the drive.

The PDO5580 is both CE and TUV compliant.

## PDO 5580 Technical Specifications

### POWER AMPLIFIER:

AMPLIFIER TYPE .....	MOSFET, dual H-Bridge, all parts rated for 100 volts.
CURRENT CONTROL .....	3 state, pulse width modulated, switching at 20–30 KHz.
OUTPUT CURRENT .....	0.5 to 5.5 amps/phase output current, switch selectable in 0.2 increments.
POWER SUPPLY .....	Linear, toroidal transformer for high reliability and low noise. 110 or 220 VAC input, switch selectable. 50–60 Hz.
DC BUS VOLTAGE .....	DC voltage at nominal line voltage: 75 VDC full load, 90 VDC no load.
AC INPUT VOLTAGE .....	110 or 220 VAC (switch selectable) 50–60 Hz.
MAXIMUM OUTPUT POWER .....	440 Watts.
PROTECTION CIRCUITS .....	Short circuit and over temperature.
IDLE CURRENT REDUCTION .....	0% or 50% dip switch selectable.
MOTOR RESOLUTION .....	Oscillator/joystick modes: 1/64 step (12,800 s/r) with 1.8° motor. Pulse & direction mode: 16 switch selectable resolutions: 200, 400, 1000, 2000, 5000, 10000, 12800, 18000, 20000, 21600, 2500, 25400, 25600, 36000, 50000, 50800 steps/rev.

### CONTROLLER SECTION:

MODE OF OPERATION .....	<p><b>Self Test:</b> Used for trouble shooting to test motor and/or signal connections.</p> <p><b>Pulse &amp; Direction:</b> Allows amplifier to receive step pulses from a controller such as Applied's Si-100 or Si-1, or any other pulse source PLC or controller.</p> <p><b>Joystick:</b> allows speed and direction to be determined by an external analog voltage. Step and Dir inputs can be used for limit switches. Speed input selects speed range. LO SPEED and HI SPEED pots adjust the 2 speed ranges.</p> <p><b>Digital Oscillator:</b> allows for precise speed control with automatic ramps between speeds. Accel/Decel rates are set by on board potentiometer and/or external analog voltage.</p>
STEP AND DIRECTION INPUT .....	Optically isolated: 5-12 VDC
SPEED RANGE .....	LO speed range: 0-5 rev/sec. HIGH speed range: 0-25 rev/sec Accel/decel range: 1-250 rev/sec/sec
TACH OUPUT .....	Optically isolated phototransistor. 30 VDC, 20mA max.

### SYSTEM SPECIFICATIONS:

OVERALL SIZE .....	3 x 5.3 x 8 inches. See mechanical outline.
CHASSIS MATERIAL .....	Aluminum, black anodized with integral heat sink.
WEIGHT .....	7.8 lbs.
AMBIENT TEMPERATURE .....	0° to 70°C.
HUMIDITY .....	Maximum of 90% non-condensing.
CONNECTORS .....	Screw terminal connectors for input power and motor, and I/O signals.
MOTORS .....	Can drive 4, 6 or 8 lead motors, NEMA sizes 23 & 34.
CASE .....	Steel with black paint and white epoxy silk screen. Integral heat sink, mounting brackets & switch covers included.
AGENCY APPROVAL .....	CE & TUV.

## PDO 5580 Technical Drawings

### MECHANICAL OUTLINE

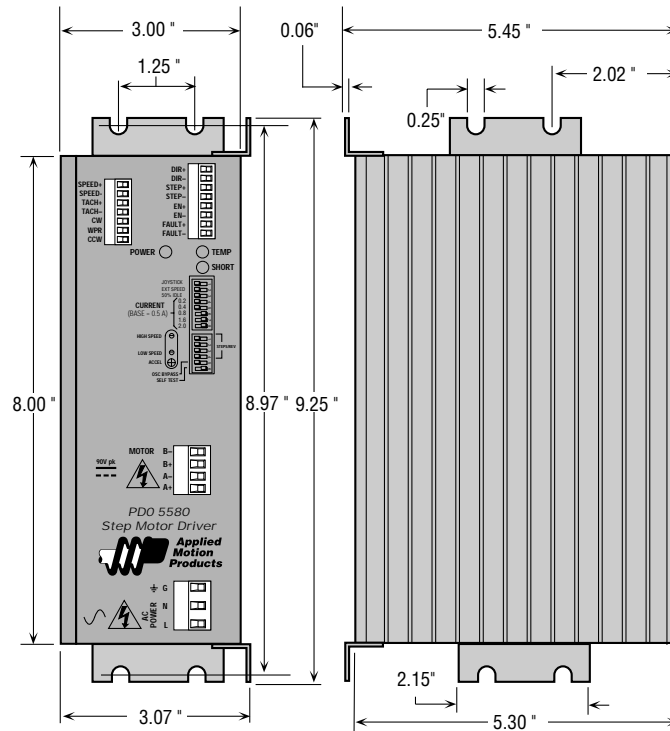

### BLOCK DIAGRAM

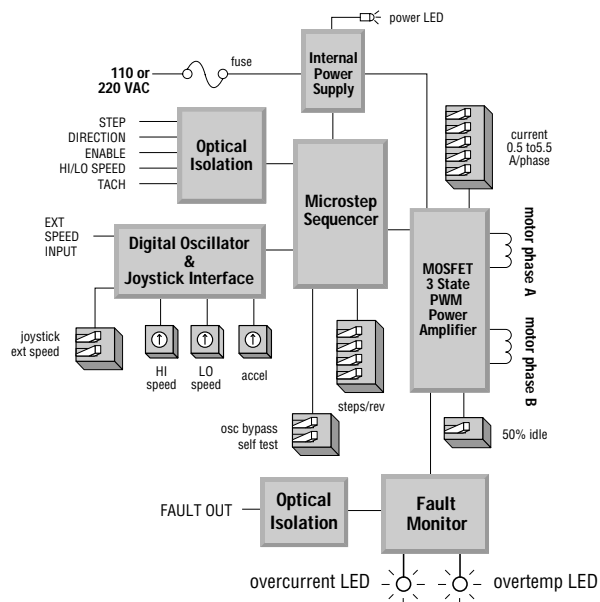

## PDO 5580 Connectors and Switches

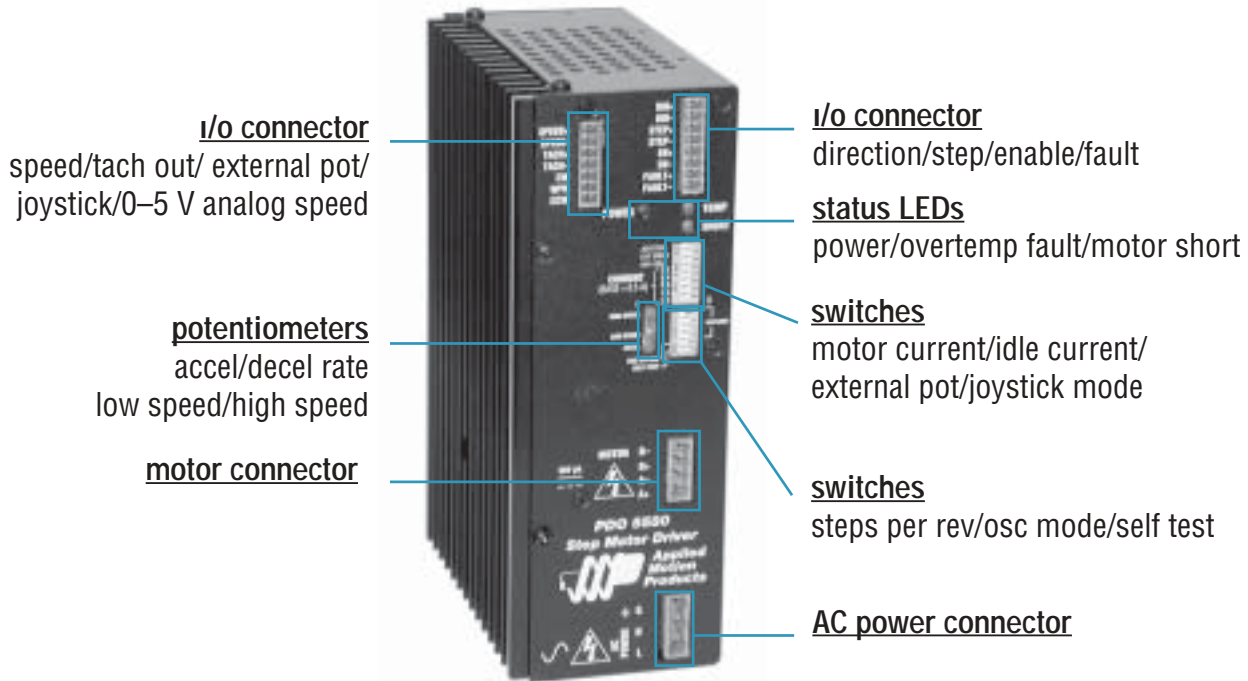

### INPUTS

position no.	
1	speed+
2	speed-
3	tach+
4	tach-
5	cw+
6	wpr-
7	ccw+

### INPUTS

position no.	
1	dir+
2	dir-
3	step+
4	step-
5	en+
6	en-
7	fault+
8	fault-

### MOTOR

position no.	
1	B-
2	B+
3	A-
4	B+

### AC POWER

position no.	
1	G
2	N
3	L

## NEMA 23 Motor Data

FEATURES	RECOMMENDED MOTORS FOR PDO 5580					
Motor P/N:	23122	23123	23124	23395	23398	23401
Motor Current amps	2.00	2.50	3.50	4.24	4.24	4.24
Resistance Ohms	1.24	1.18	0.82	0.32	0.38	0.50
Holding Torque oz-in	98	158	225	77	177	264
Rotor Inertia oz-in <sup>2</sup>	0.55	1.14	1.72	0.66	1.64	2.62
<b>Bearings</b>						
Thrust Load (lbs)	25	25	25	25	25	25
Radial Load (lbs)	15	15	15	15	15	15
Radial Play inch/lbs	.001 max @ 1 lb	.001 max @ 1 lb	.001 max @ 1 lb	.001 max @ 1 lb	.001 max @ 1 lb	.001 max @ 1 lb
End Play inch/lbs	.001 max @ 9 lbs	.001 max @ 9 lbs	.001 max @ 9 lbs	.003 max @ 2.2 lbs	.003 max @ 2.2 lbs	.003 max @ 2.2 lbs
Weight lbs.	1.17	2.00	2.80	1.00	1.54	2.20

Motor current, resistance and torque ratings are with parallel connection

## NEMA 23 Motor Dimensions

Model	L
23122	2.00"
23123	3.00"
23124	4.00"

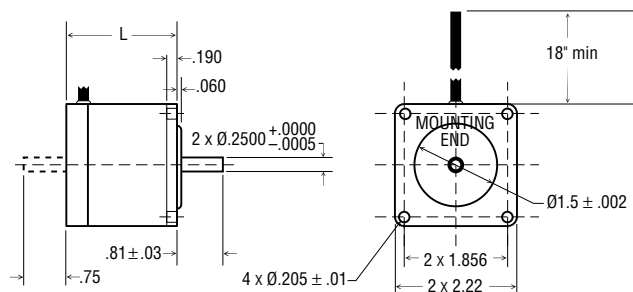

Model	L
23395	1.54"
23398	2.13"
23401	2.99"

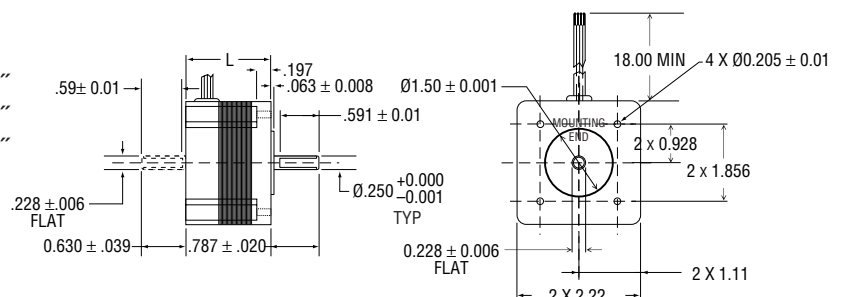

## Torque Curves

### PDO 5580 with NEMA 23 Step Motors

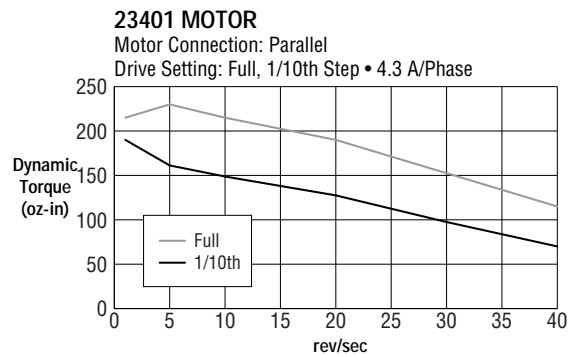
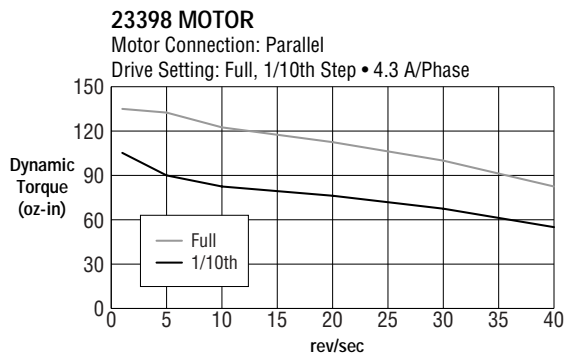
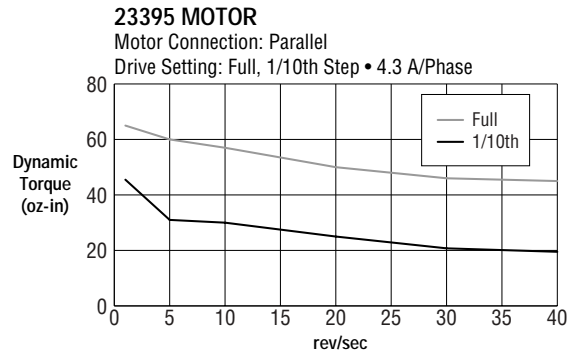
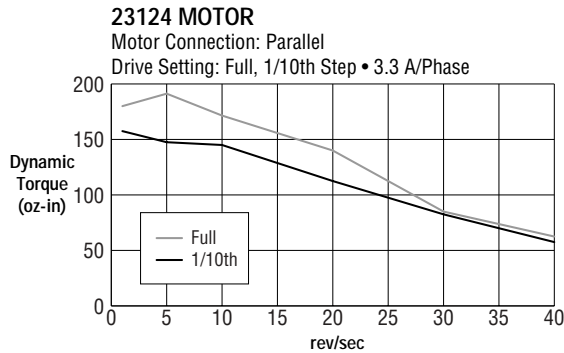
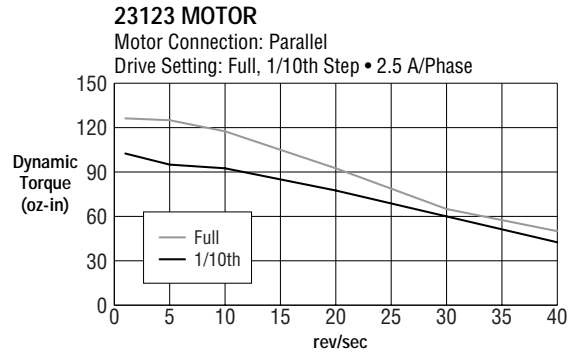
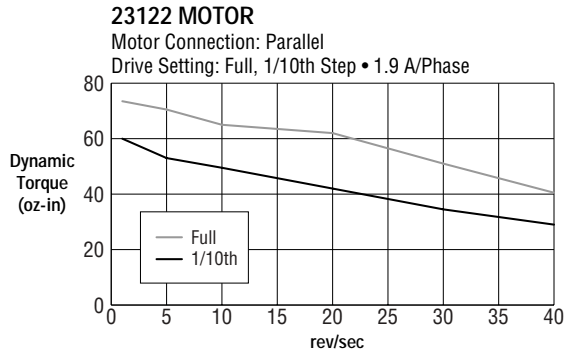

## NEMA 34 Motor Data

FEATURES	RECOMMENDED MOTORS FOR PDO 5580					
Motor P/N:	34348	34349	34350	34474	34476	34478
Motor Current amps	4.48	7.07	8.34	6.35	6.35	5.64
Resistance Ohms	0.30	0.25	0.20	0.24	0.33	0.49
Holding Torque oz-in	212	424	636	389	855	1283
Rotor Inertia oz-in <sup>2</sup>	3.66	6.72	10.20	7.65	14.80	21.90
<b>Bearings</b>						
Thrust Load (lbs)	50	50	50	35	35	35
Radial Load (lbs)	25	25	25	30	30	30
Radial Play inch/lbs	.001 max @ 1 lb	.001 max @ 1 lb	.001 max @ 1 lb	.0008 max @ 1 lb	.0008 max @ 1 lb	.0008 max @ 1 lb
End Play inch/lbs	.001 max @ 15 lbs	.001 max @ 15 lbs	.001 max @ 15 lbs	.003 max @ 1 lbs	.003 max @ 1 lbs	.003 max @ 1 lbs
Weight lbs.	3.00	5.40	7.70	3.86	6.18	8.66

Motor current, resistance and torque ratings are with parallel connection

## NEMA 34 Motor Dimensions

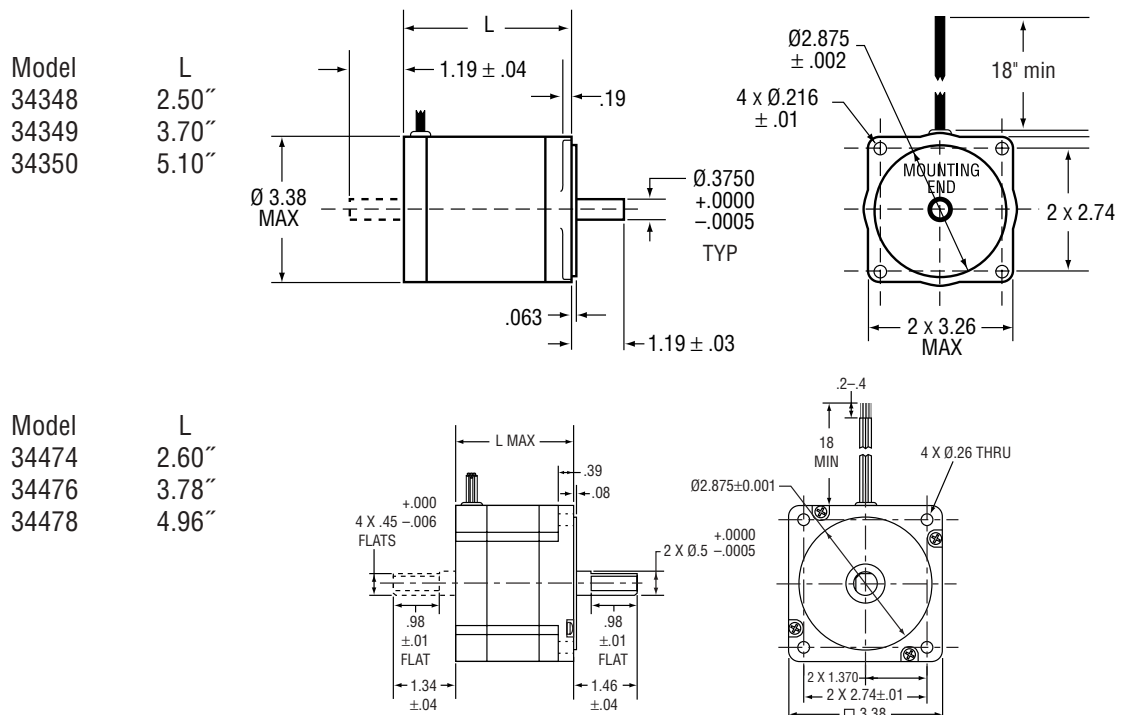

## Torque Curves

### PDO 5580 with NEMA 34 Step Motors

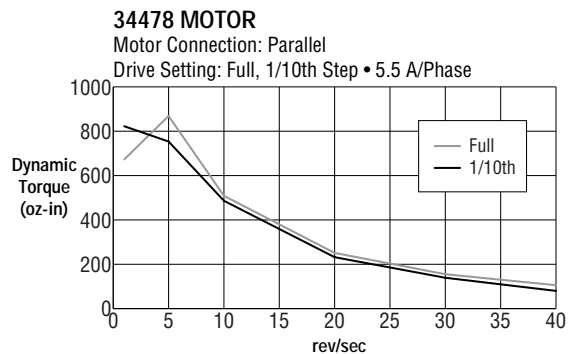
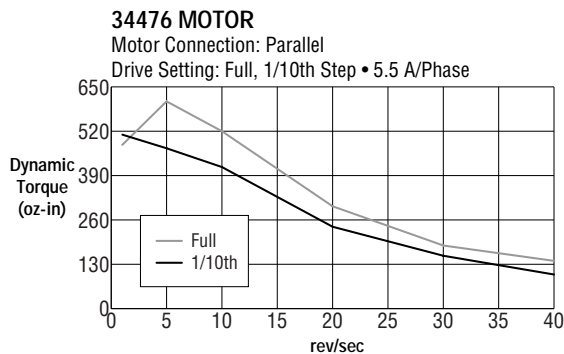
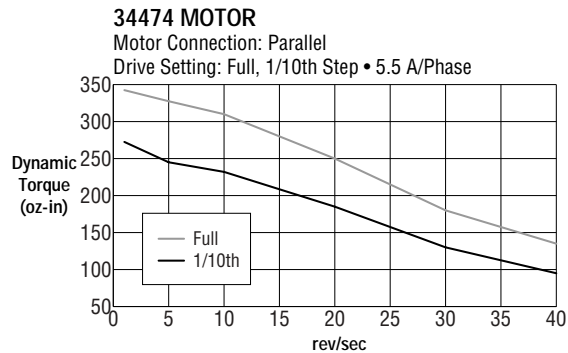
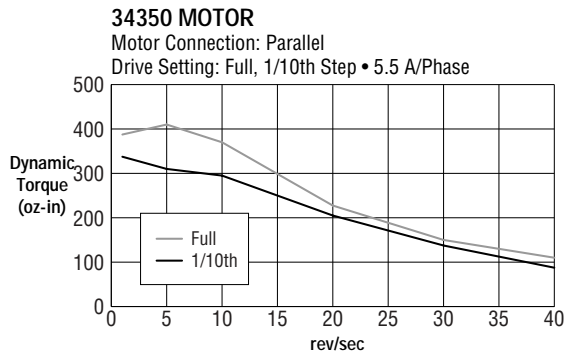
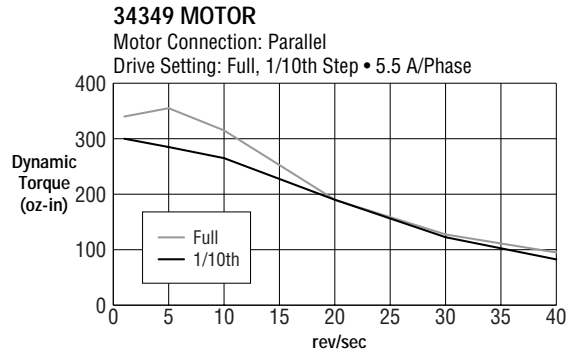
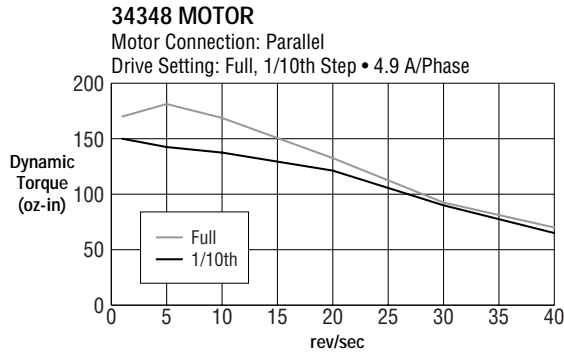



## COMPLETE SYSTEM ORDERING

Drive Type	Motor System Number	Step Motor Description
PDO 5580	23122	NEMA 23 one stack
Si5580	23123	NEMA 23 two stack
	23124	NEMA 23 three stack
	23395	NEMA 23 high torque one stack
	23398	NEMA 23 high torque two stack
	23401	NEMA 23 high torque three stack
	34348	NEMA 34 one stack
	34349	NEMA 34 two stack
	34350	NEMA 34 three stack
	34474	NEMA 34 high torque one stack
	34476	NEMA 34 high torque two stack
34478	NEMA 34 high torque three stack	

System Ordering Example: PDO 5580 - 23122

## DRIVE ONLY ORDERING

Drive Type	Description
PDO 5580	Packaged 5.5 amps, 80 VDC, 110/220 VAC input. Microstepping pulse & direction/oscillator drive.
Si5580	Packaged 5.5 amps, 80 VDC, 110/220 VAC input. Microstepping fully programmable drive/indexer with <i>Si™</i> software.



404 Westridge Dr. • Watsonville, CA 95076  
831/761-6555 • 800/525-1609 • FAX 831/761-6544  
[www.appliedmotionproducts.com](http://www.appliedmotionproducts.com)

---