

7080 Step Motor Drive

Microstepping
7.0 amps, 80 VDC

Features

- DC bus voltage 24-80 VDC motor supply (including ripple)
- Switch selectable currents from 0.8-7.0 amps/phase motor current
- Switch selectable Step resolutions from 200 to 50,800 steps/rev
- Switch selectable idle current reduction, 0% or 50%
- Optically isolated 5-24 VDC inputs for step, direction and enable
- Enable input to turn off current to the motor
- 560 watts of usable power
- Short circuit and thermal protection
- Screw terminal connectors for power and motor
- MOSFET, dual H-bridge, inaudible PWM amplifier
- 3 state, pulse width modulated current control, switching at 20-30 KHz
- Drives 4, 6 or 8 lead size 11, 14, 17, 23, or 34 step motors
- CE compliant

Description

The 7080 step motor driver is a microstepping drive from 200 to 50,800 steps per revolution, step phase sequencer with MOSFET three state switching amplifiers and optoisolated circuits. The drive also includes an automatic feature to lower motor current by 50% anytime the motor is left at rest for more than one second. This feature can be disabled.

The amplifier regulates motor current by chopping at a constant, inaudible frequency. Phase current is selected by a DIP switch. Microstepping resolution is also selected by DIP switch.

Recommended motors for the 7080 drive:

Size 17	Size 23	Size 34
HT17-068	HT23-395	HT34-474
HT17-071	HT23-398	HT34-476
HT17-075	HT23-401	HT34-478

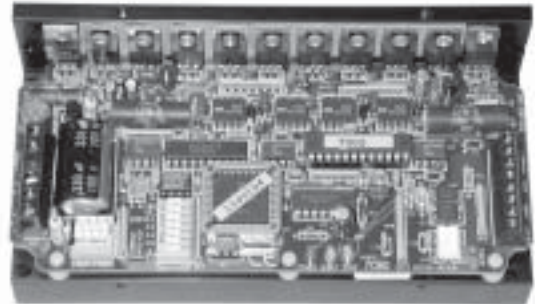

MECHANICAL OUTLINE

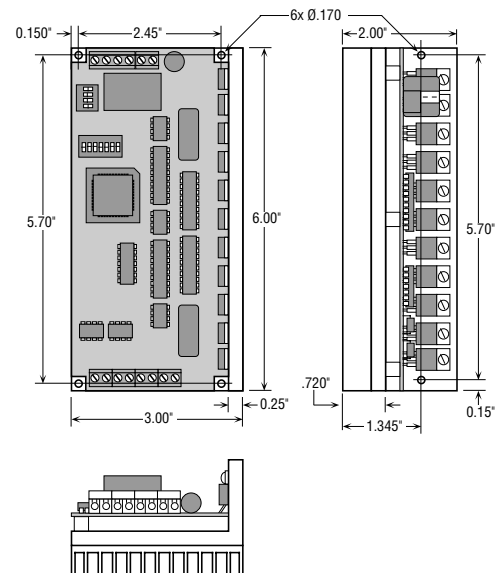

BLOCK DIAGRAM

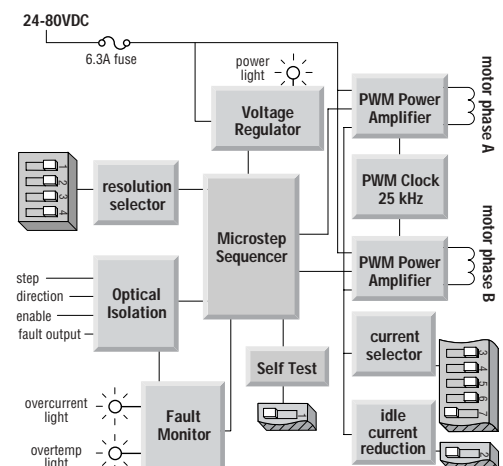

7080 Torque Curves

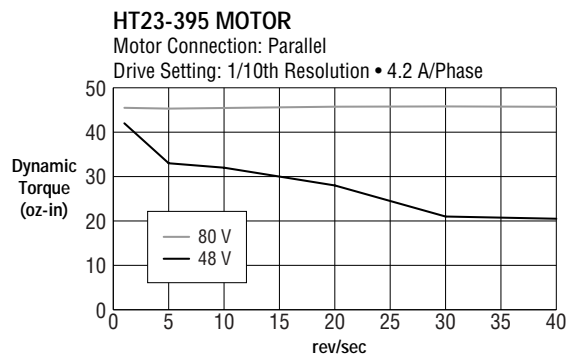
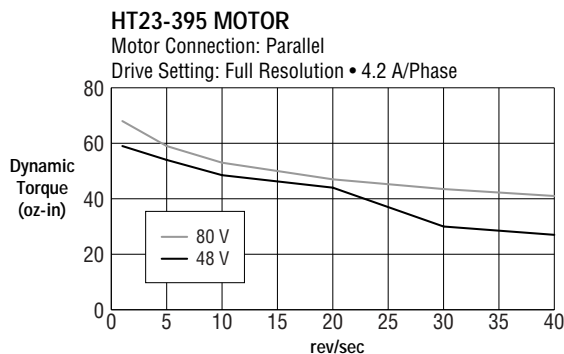
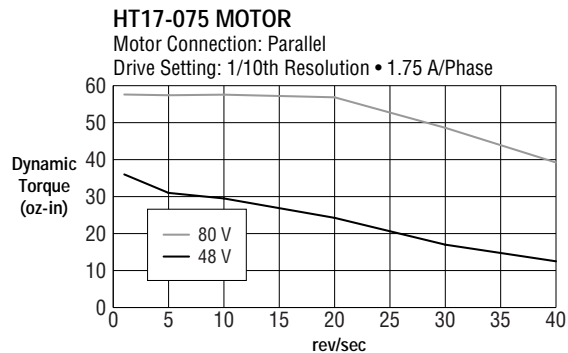
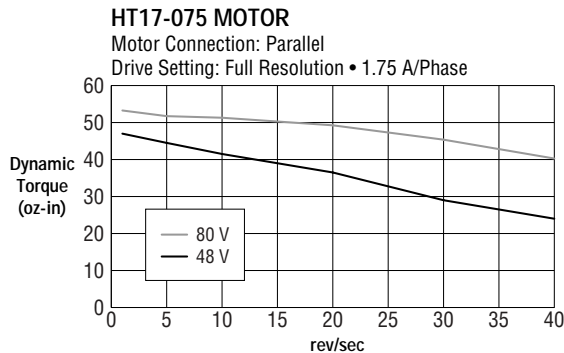
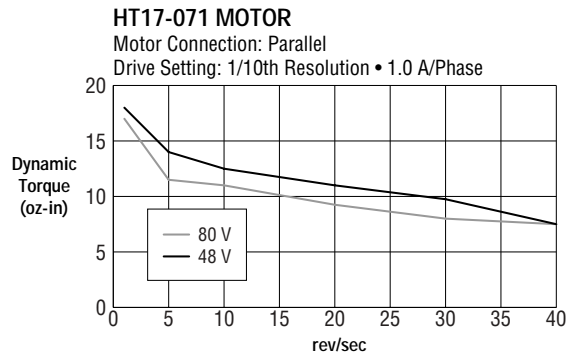
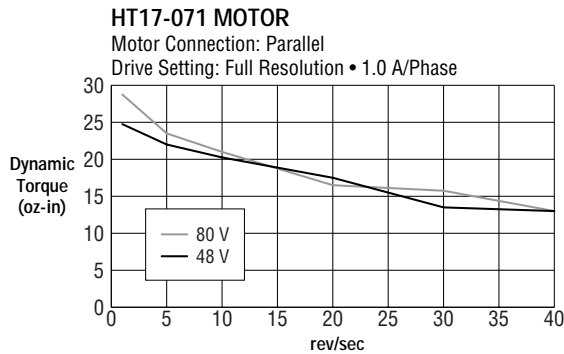
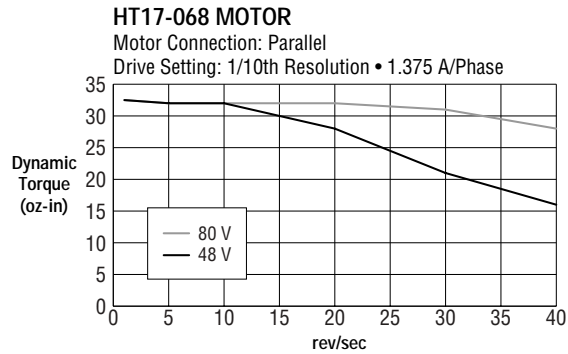
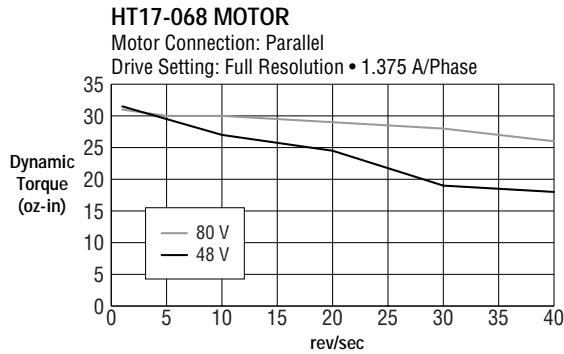

7080 Torque Curves

HT23-398 MOTOR

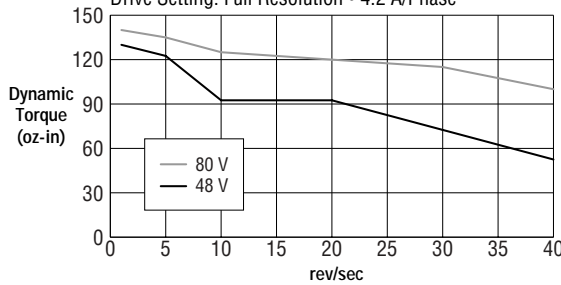
 Motor Connection: Parallel
 Drive Setting: Full Resolution • 4.2 A/Phase

HT23-398 MOTOR

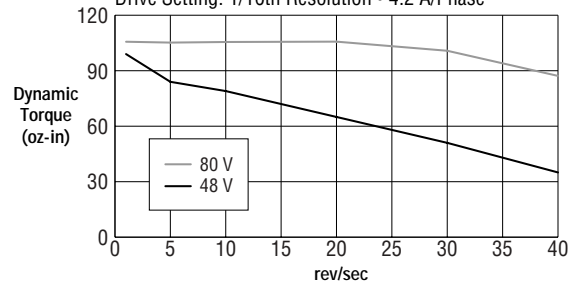
 Motor Connection: Parallel
 Drive Setting: 1/10th Resolution • 4.2 A/Phase

HT23-401 MOTOR

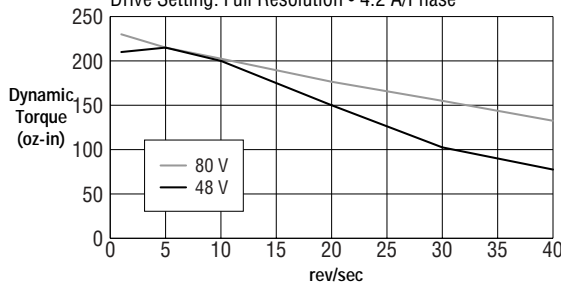
 Motor Connection: Parallel
 Drive Setting: Full Resolution • 4.2 A/Phase

HT23-401 MOTOR

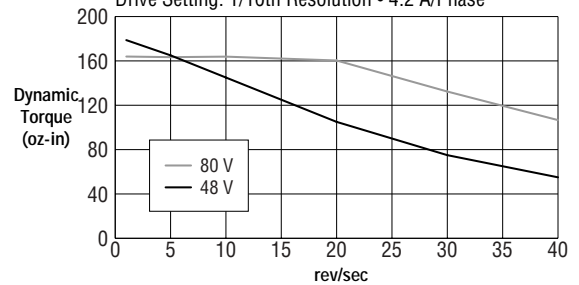
 Motor Connection: Parallel
 Drive Setting: 1/10th Resolution • 4.2 A/Phase

HT34-474 MOTOR

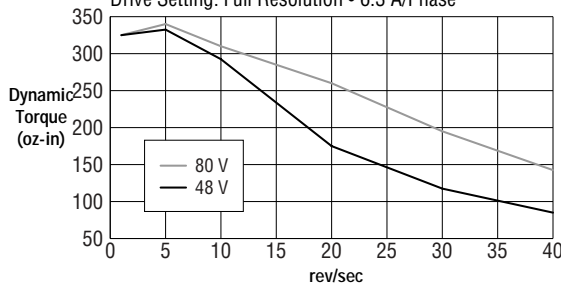
 Motor Connection: Parallel
 Drive Setting: Full Resolution • 6.3 A/Phase

HT34-474 MOTOR

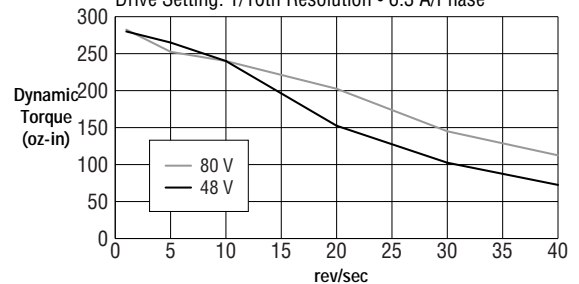
 Motor Connection: Parallel
 Drive Setting: 1/10th Resolution • 6.3 A/Phase

HT34-476 MOTOR

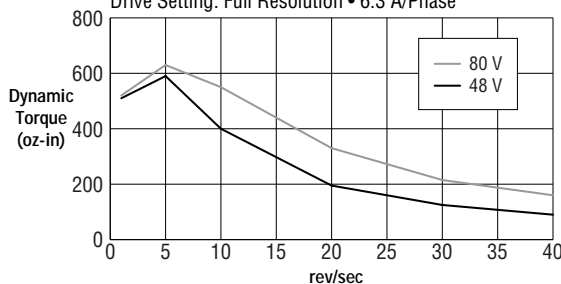
 Motor Connection: Parallel
 Drive Setting: Full Resolution • 6.3 A/Phase

HT34-476 MOTOR

 Motor Connection: Parallel
 Drive Setting: 1/10th Resolution • 6.3 A/Phase
